



CONTRACTOR PUMPS & GENERATORS  
**BUILT FOR WORK**

Electric Submersible Pumps • Engine Driven Pumps • Generators • Accessories



[www.tsurumipump.com](http://www.tsurumipump.com)

# **TSURUMI PUMP** Electric Submersible Pumps

## LB Series • HS Series Features

### Long-life by design

**1** TOP DISCHARGE, FLOW THRU DESIGN

**2** MULTI-DIRECTIONAL DISCHARGE CONNECTOR: Can be configured for horizontal or vertical discharge. Providing for a more stable installation.

**3** RUBBER CASING WITH LARGE ROUNDED CUT-WATERS: Resists wear and degradation of performance due to abrasive particles.

**4** CABLE BOOT: Prevents kinking at cable entrance by extending bending radius.

**5** ANTI-WICKING BLOCK: Prevents water incursion due to capillary wicking, should the power cable be damaged or the end submerged.

**6** DUAL INSIDE MECHANICAL SEAL WITH SILICON CARBIDE FACES: Provides longer operational life of any seal available.

**7** OIL LIFTER: Provides lubrication of the seal faces down to 1/3 of normal oil level and extends seal life by ten times—uses no additional power.

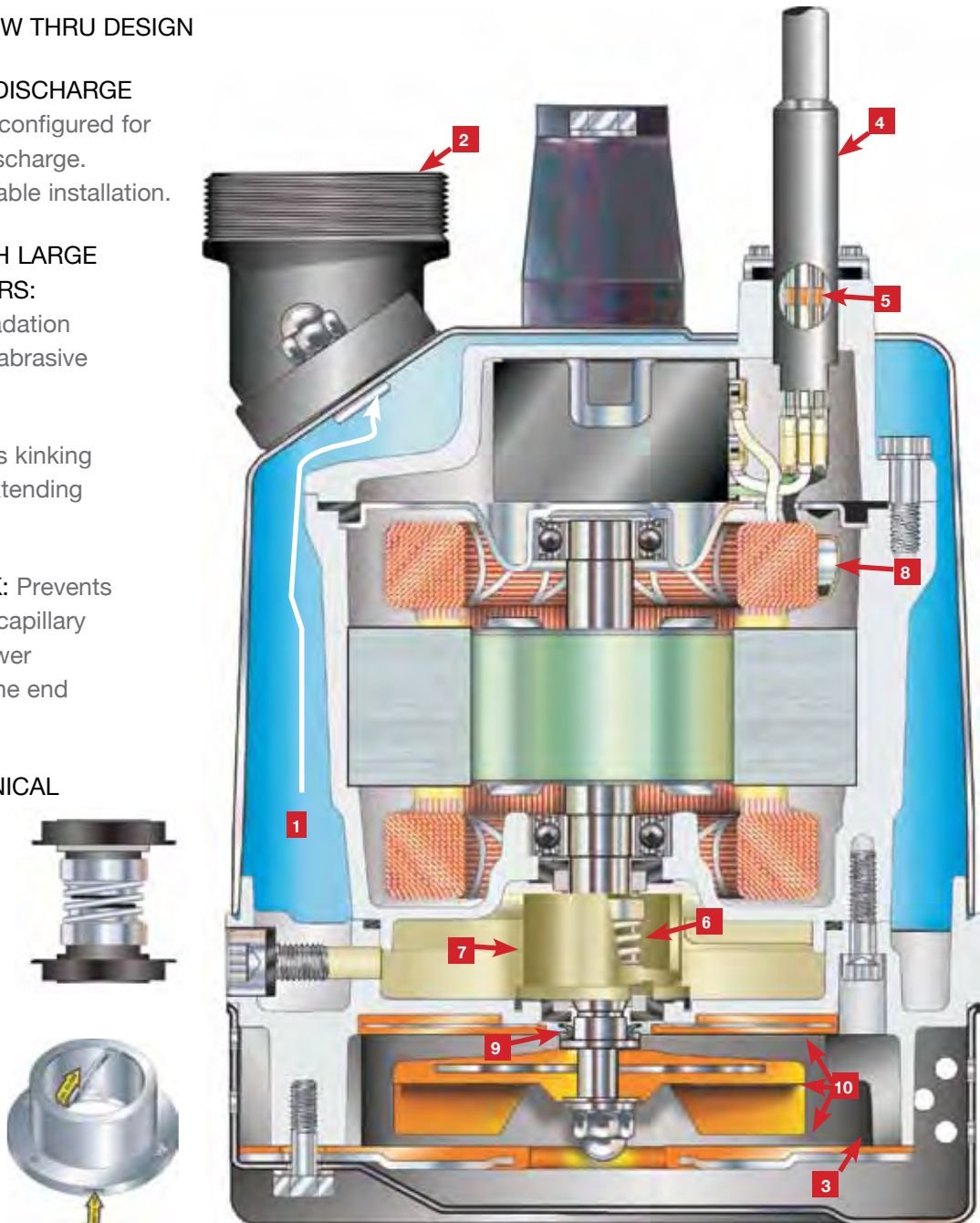

Featured Model LB-480

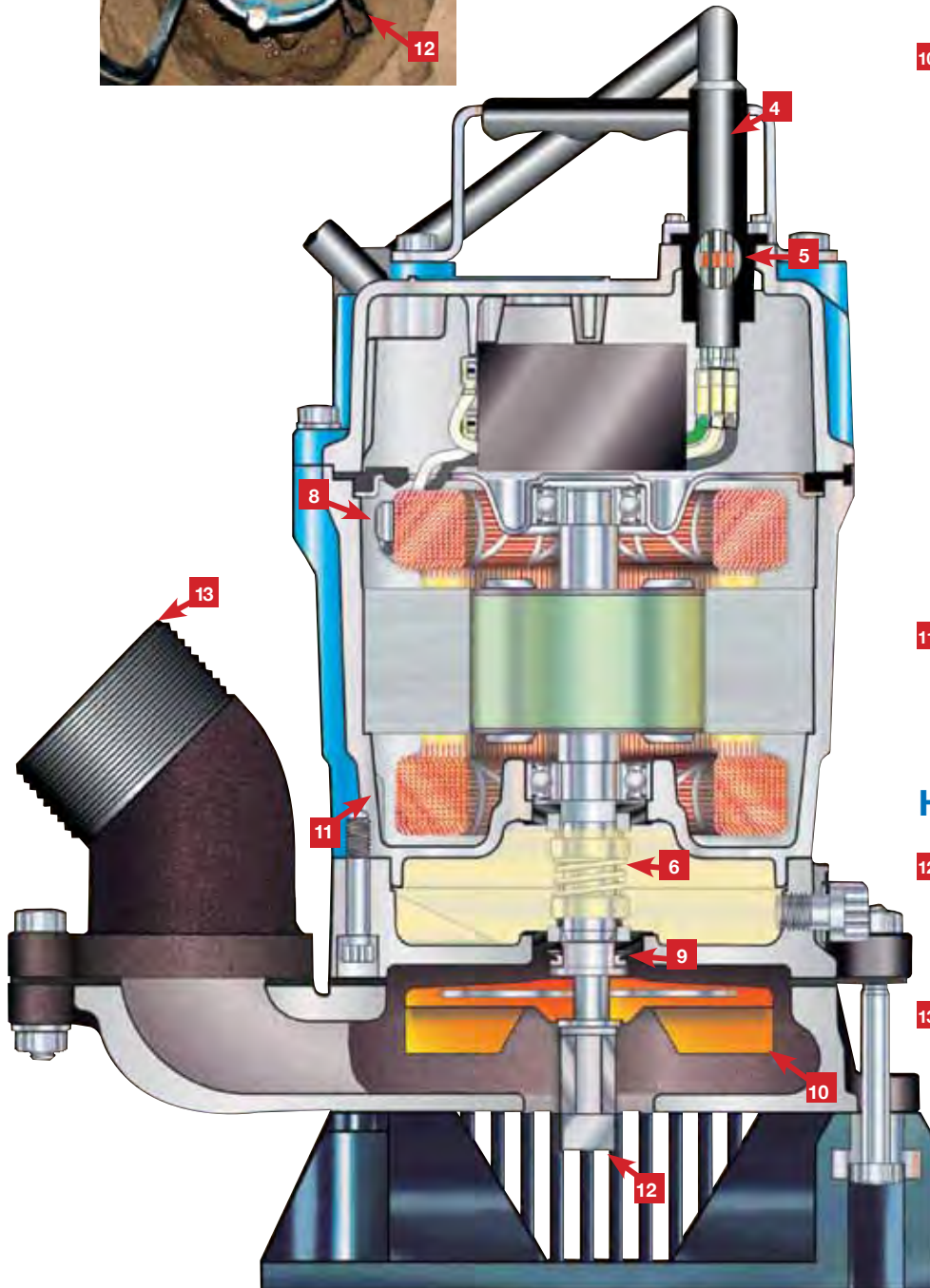

Featured Model HS2.4S

- 8** MINIATURE THERMAL MOTOR PROTECTOR: Protects against, overheating & run-dry.
- 9** V-RING SEAL PROTECTOR: Protects mechanical seal from abrasive particles.
- 10** URETHANE, SEMI-VORTEX IMPELLER & WEAR PLATES: Resists wear by abrasive particles and does not depend on close tolerances to maintain pump performance.



Tsurumi Impeller  
polished, not worn by  
abrasive material.



Competitor Impeller  
is effectively worn out.

- 11** COPPER WINDINGS WITH CLASS E INSULATION: Operates at lower temperatures, extending insulation and bearing life.

## HS Features

- 12** AGITATOR: Suspends sand and mud, allowing for sediment removal from sumps or basins.
- 13** 45° ANGLED DISCHARGE CONNECTOR: Provides for a more stable installation for either vertical or horizontal discharge hose.

(Not all features available on every Tsurumi submersible pump.)

# Electric Submersible Pumps

## GROUP PERFORMANCE RANGE

### Reliable and cost-effective pumps

enable Tsurumi to remain an industry leader in the rental and construction markets. Our customers know that while many pumps may look the same, only Tsurumi incorporates the most durable components into the final manufactured product.



## GROUP PERFORMANCE RANGE

### ELECTRIC SUBMERSIBLE PUMPS: SINGLE PHASE & THREE PHASE

Electric Submersible Pumps: Under 1HP

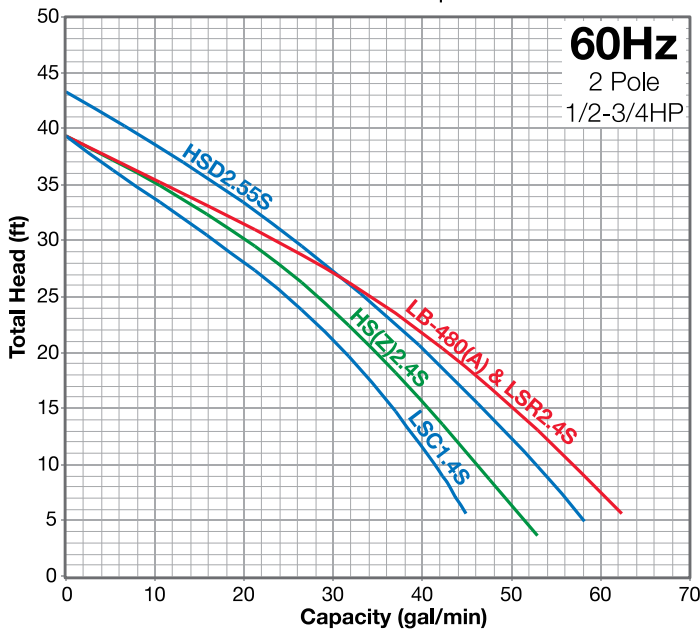

Electric Submersible Pumps: 1HP or more

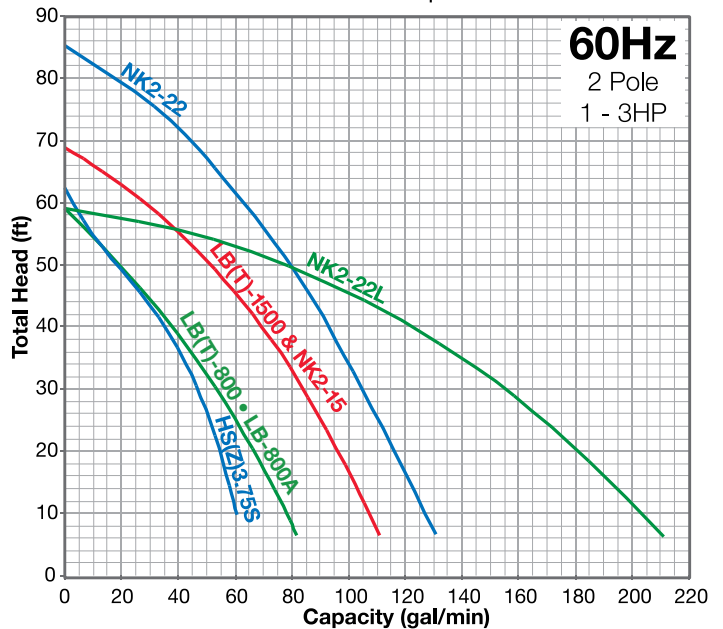

# Electric Submersible Pumps

## LB-480 • LB-480A DEWATERING PUMPS

**LB-480 Slimline design pump** allows to fit into 8" pipes. Powerful pumps built with durable materials in an easy handling design. Top discharge provides maximum motor cooling efficiency allowing continuous duty operation at low water levels and extended dry-run capability. **LB-480A Automatic Submersible Pump** performs like the non-automatic version in every aspect of construction site usage requiring a tough and durable pump.



LB-480

### LB-480 Features

- Urethane, Semi Vortex Impeller and Wear Plates for maximum durability and maintaining pump performance.
- Dual Inside Mechanical Seal With SiC faces provides longer operational life.
- Oil Lifter provides lubrication of the seal faces. (Patented)
- V-Ring Seal design protects mechanical seal from abrasive particles.

### Optional Accessories

- TS-301 Float Switch for automatic operation.

### LB-480A Features

- No control panel or float switches required.
- Performs like the non-automatic pump with no special float installation required.
- Requires very small space to operate - only 8 3/4" diameter.
- Urethane, Semi Vortex Impeller and Wear Plates for maximum durability with maintaining pump performance.
- Oil Lifter provides lubrication of the seal faces. (Patented)
- V-Ring Seal Protector designs mechanical seal from abrasive particles.
- Environmentally friendly, reducing electrical costs and operational noise.



LB-480A

### Technical Features of EL Relay Unit (Level Sensor)

- Sensitive electrodes detect water to start pump operation even when foreign materials are present.
- Internal timer eliminates frequent on/off operation in rough water to extend motor life.
- Relay sensor completely molded in resin and covered by rubber case for protection against rough handling.
- Jobsite tested for more than 30,000 on-off cycles without failure or damage.

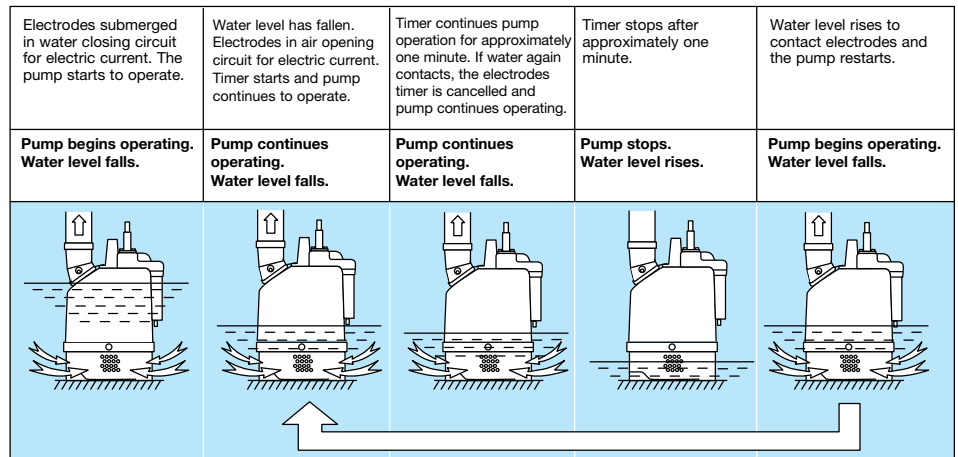
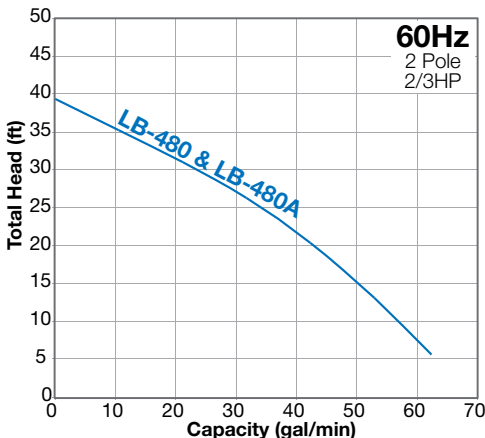

Certified by Intertek Testing Service to UL and CSA standards for submersible construction pumps.

Model	Motor Output (HP)	Phase	Discharge Bore (inch)	Cable Length (ft)	Dimension (inch)		Continuous Running Water Level (inch)	Shipping Weight (lbs.)
					Diameter	Height		
LB-480	2/3	Single	2	32	7 11/16	11 1/4	2	28
LB-480A	2/3	Single	2	32	8 3/4	11 1/4	4 1/2 *	30

\* Pump Starting Water Level

# Electric Submersible Pumps

## LB(T)-800 • LB-800A DEWATERING PUMPS



**LB-800 • LBT-800 Slimline design pumps** allow to fit into 8" pipes. Powerful pump built with durable materials in an easy handling design. Top discharge provides maximum motor cooling efficiency allowing continuous duty operation at low levels and extended dry-run capability.

### LB-800 (Single Phase) • LBT-800 (Three Phase) Features

- Designed to fit an 8" pipe.
- Up to 59' shut off head.
- Available in 230V single-phase for lower amperage draw and longer cable extensions.
- Dual Inside Mechanical Seal With SiC faces provides longer operational life.
- Oil Lifter provides lubrication of the seal faces. (Patented)
- LB-800 (Single Phase) and LBT-800 (Three Phase) are available.

### Optional Accessories

- Float Switch for automatic operation TS-302 for 115V, TS-303 for 230V.



**NEW Dewatering pump LB-800A** features the Relay Unit (Level Sensor) which incorporates low voltage, stainless steel probes, epoxy and rubber encapsulated timing relay, that turns the unit off when liquid is not present. It saves energy and extends the life of the motor and bearings!



### LB-800A (Single Phase) pump Features

- Up to 59' shut off head.
- Dual Inside Mechanical Seal With SiC faces provides longer operational life.
- Oil Lifter provides lubrication of the seal faces. (Patented)

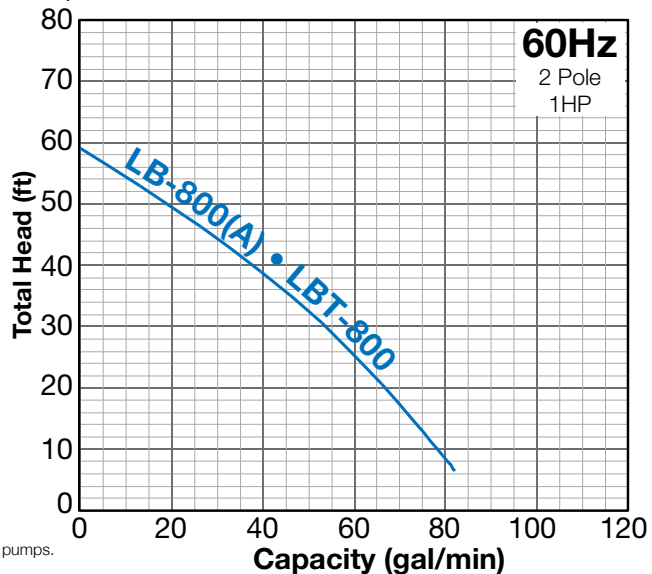

Certified by Intertek Testing Service to UL and CSA standards for submersible construction pumps.

### LB-800 • LBT-800

Model	Motor Output (HP)	Phase	Discharge Bore (inch)	Cable Length (ft)	Dimension (inch)		Continuous Running Water Level (inch)	Shipping Weight (lbs.)
					Diameter	Height		
LB-800	1	Single	2	50	7 9/16	13 7/16	2	35
LBT-800	1	Three	2	50	7 9/16	13 7/16	2	35

### LB-800A

Model	Motor Output (HP)	Phase	Discharge Bore (inch)	Cable Length (ft)	Dimension (inch)		Pump Starting Water Level (in.)	Shipping Weight (lbs.)
					Diameter	Height		
LB-800A	1	Single	2	50	8 3/4	13 7/16	6 3/4	36

# Electric Submersible Pumps

## LB-1500 • LBT-1500 DEWATERING PUMP

**LB-1500 • LBT-1500 Slimline design pumps** fit into 8" pipes. Powerful pump built with durable materials in an easy handling design. Top discharge provides maximum motor cooling efficiency allowing continuous duty operation at low levels and extended dry-run capability.



### LB-1500 (Single Phase) • LBT-1500 (Three Phase) Features

- Circle Thermal Motor Protector: Protects against, overheating over amperage & run-dry.
- Anti-Wicking Block: Prevents water incursion due to capillary wicking, should the power cable be damaged or the end submerged.
- Oil Lifter: Lubricates the seal faces down to 1/3 of normal oil level and extends seal life by ten times using no additional power.
- Dual inside mechanical seals with silicon carbide faces, (both top and bottom) running in an oil filled chamber provides for the most durable seal design available.
- High Chrome Iron Semi-Open Impeller: Resists wear from abrasive particles.
- Synthetic Rubber Pump Casting: For wear resistance and easy maintenance.
- V-Ring System: Protects the shaft seals.

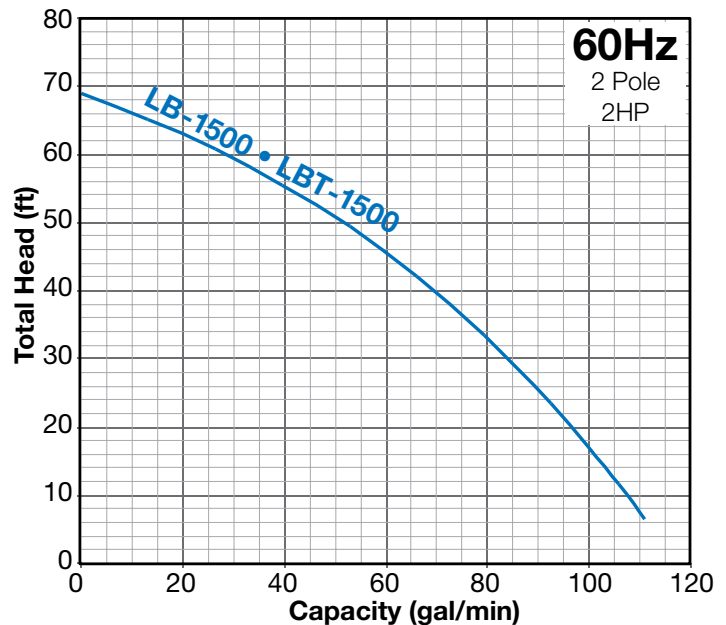

Certified by Intertek Testing Service to UL and CSA standards for submersible construction pumps.

Model	Motor Output (HP)	Phase	Discharge Bore (inch)	Cable Length (ft)	Dimension (inch)		Pump Starting Water Level (in.)	Shipping Weight (lbs.)
					Diameter	Height		
LB-1500	2	Single	*2 or 3	50	7 3/8	23 5/16	3 1/8	85
LBT-1500	2	Three	*2 or 3	50	7 3/8	23 5/16	3 1/8	85

\*2" is optional

# Electric Submersible Pumps

## HS HSZ TRASH PUMP



### HS TRASH PUMP

Durable trash pumps in two sizes—a 1HP 3-inch discharge and a 1/2HP 2-inch discharge. Both designed to pump sand, solids and debris with minimal wear and clogging.

### HSZ AUTOMATIC TRASH PUMP

Automatic trash pumps in two sizes, designed to pump sand, solids and debris with minimal wear and clogging.

### HS HSZ TRASH PUMP Features

- Built-in shaft mounted agitator suspends solids.
- Urethane Semi Vortex Impeller for maximum durability and pump performance.
- Dual Inside Mechanical Seal With SiC faces provides longest operational life.
- Oil Lifter provides lubrication of the seal faces. (Patented)
- V-Ring Seal design protects mechanical seal from abrasive particles.

#### Optional Accessories

- Vertical Discharge Coupling.
- 2-inch NPT coupling available for HS(Z)3.75S.

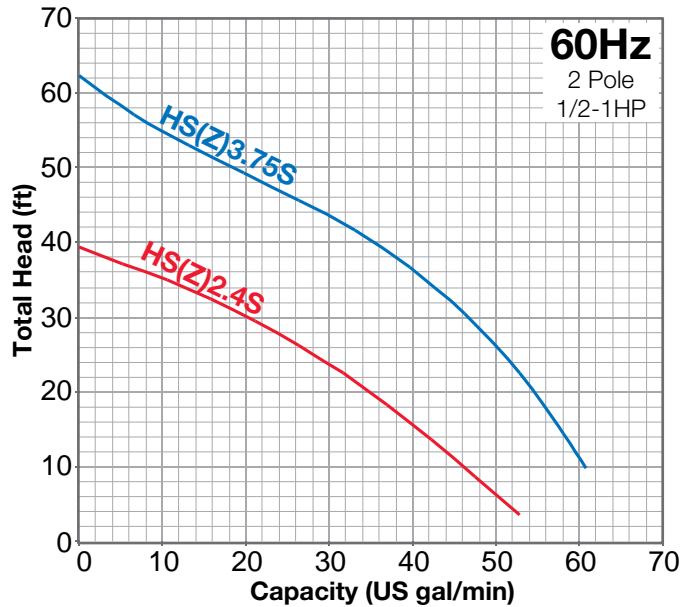

Certified by Intertek Testing Service to UL and CSA standards for submersible construction pumps.

### HS2.4S / 3.75S

Model	Motor Output (HP)	Phase	Discharge Bore (inch)	Cable Length (ft)	Dimension (inch)		Continuous Running Water Level (inch)	Shipping Weight (lbs.)
					Diameter	Height		
HS2.4S	1/2	Single	2	20	10 1/16	12 15/16	3 1/2	30
HS3.75S	1	Single	3	32	12 7/16	15 1/4	3 1/2	49

### HSZ2.4S / 3.75S

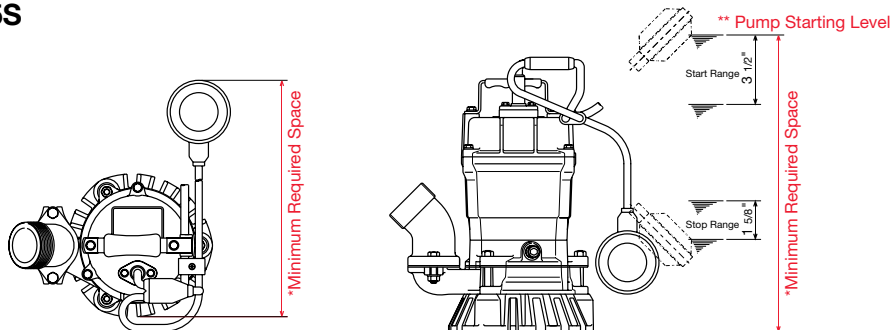

Model	Motor Output (HP)	Phase	Discharge Bore (inch)	Cable Length (ft)	Dimension (inch)		**Pump Starting Water Level (inch)	Shipping Weight (lbs.)
					*Diameter	*Height		
HSZ2.4S	1/2	Single	2	20	13 1/2	15 1/8	15 1/8	30
HSZ3.75S	1	Single	3	32	13 1/2	17 1/2	17 1/2	49

\*Minimum Required Space

\*\*Please refer HSZ dimension drawing above



# Electric Submersible Pumps

## HSD SERIES SAND PUMP

**EXTREME DURABLE TRASH PUMP:** Pump sand, solids and debris with minimal wear and clogging.

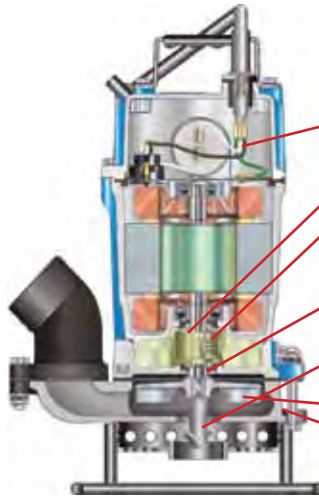

### HSD Series Features

- Anti-wicking block prevents water incursion.
- Oil Lifter extends seal life by ten times.
- Dual Inside Mechanical Seal with silicon carbide faces provides longer operational life of any seal available.
- V-Ring Seal design protects mechanical seal from abrasive particles.
- Built-in larger shaft mounted agitator suspends solids.
- High Chromium Iron impeller.
- Ductile Iron Casing.
- 3/4 HP motor; larger than HS2.4S.
- Easy pump end disassembly by removing only 3 nuts.

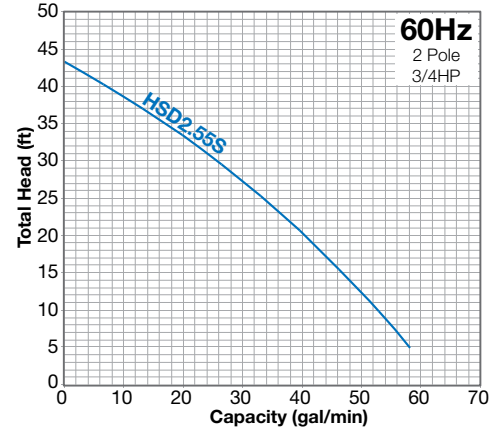

Certified by Intertek Testing Service to UL and CSA standards for submersible construction pumps.

Model	Motor Output (HP)	Phase	Discharge Bore (inch)	Cable Length (ft)	Dimension (inch)		Continuous Running Water Level (inch)	Shipping Weight (lbs.)
					Diameter	Height		
HSD2.55S	3/4	Single	2	32	9 3/4	15 3/8	4 1/8	36

## NK HEAVY DUTY HIGH HEAD PUMP

Heavy duty, high head pumps capable of handling abrasive materials with minimal wear.

### NK2-15/2-22/2-22L Features

- Terminal board for voltage reconnect allows for change from 110V to 220V (NK2-15 only).
- **NK2-15/2-22:** Semi Vortex Impeller and Synthetic Rubber Wear Plates for maximum durability and maintaining pump performance.
- **NK2-22L:** Semi-Open Impeller.
- Dual Inside Mechanical Seal With SiC faces provides longer operational life.
- Oil Lifter provides lubrication of the seal faces. (Patent)
- V-Ring Seal design protects mechanical seal from abrasive particles.

#### Optional Accessories

- TS-303 Float Switch for automatic operation (220V only).
- Sand kit to suspend solids and prevent clogging.
- 2-inch NPT coupling available.

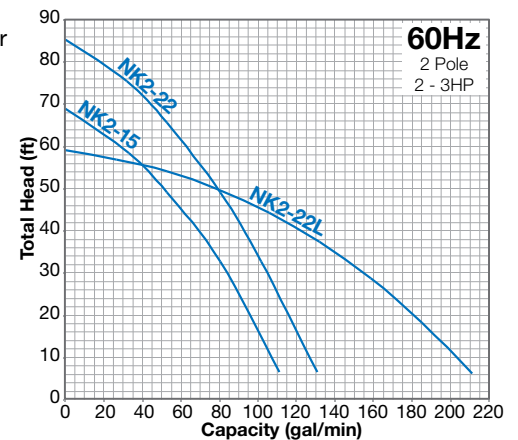

Certified by Intertek Testing Service to UL and CSA standards for submersible construction pumps.

Model	Motor Output (HP)	Phase	Discharge Bore (inch)	Cable Length (ft)	Dimension (inch)		Continuous Running Water Level (inch)	Shipping Weight (lbs.)
					Diameter	Height		
NK2-15	2	Single	3	32	9 7/16	24 1/2	3 1/4	80
NK2-22	3	Single	3	32	9 7/16	24 1/2	3 1/4	78
NK2-22L	3	Single	3	32	9 1/4	26 1/2	4 3/4	84

# Electric Submersible Pumps

## LSR GROUND DRAINAGE PUMP

Pump holds suction for drainage to 0.2 inch water level.



### LSR2.4S Features

- Urethane, Semi Vortex Impeller and Wear Plates for maximum durability and maintaining pump performance.
- Dual Inside Mechanical Seal With SiC faces provides longer operational life.
- Oil Lifter provides lubrication of the seal faces. (Patented)
- V-Ring Seal design protects mechanical seal from abrasive particles.

### Optional Accessory

- TS-301 Float Switch for automatic operation. (Use of float switch will not permit low level pumping.)

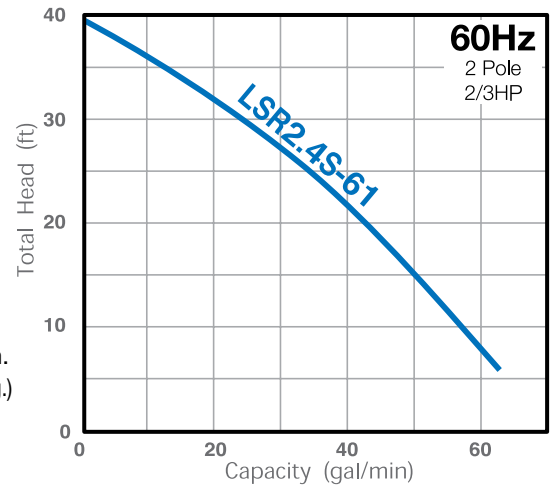

Certified by Intertek Testing Service to UL and CSA standards for submersible construction pumps.

Model	Motor Output (HP)	Phase	Discharge Bore (inch)	Cable Length (ft)	Dimension (inch)		Continuous Running Water Level (inch)	Shipping Weight (lbs.)
					Diameter	Height		
LSR2.4S	2/3	Single	2	32	8 1/4	11 3/8	0.2	28

## LSC GROUND DRAINAGE PUMP

Original residue dewatering pump; able to pump down to the floor, even the smallest puddle can be pumped dry. LSC drainage pump is the best for complete drainage of flat surfaces where a sump is not available.



### LSC1.4S Features

- Prime pump through discharge outlet for start up at any water level.
- Internal check valve holds prime and prohibits back flow through pump when stopped.
- Urethane, Semi Vortex Impeller and Wear Plates for maximum durability and maintaining pump performance.
- Dual Inside Mechanical Seal With SiC faces provides longer operational life.
- Oil Lifter provides lubrication of the seal faces. (Patented)
- V-Ring Seal design protects mechanical seal from abrasive particles.

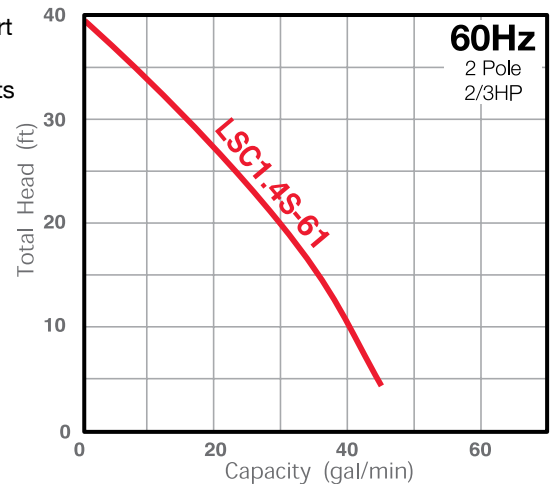

Certified by Intertek Testing Service to UL and CSA standards for submersible construction pumps.

Model	Motor Output (HP)	Phase	Discharge Bore (inch)	Cable Length (ft)	Dimension (inch)		Continuous Running Water Level (inch)	Shipping Weight (lbs.)
					Diameter	Height		
LSC1.4S	2/3	Single	3/4	20	7 11/16	12 7/16	0.04	29

# Electric Submersible Pumps

## F-13 UTILITY PUMP



Oil free economical submersible pumps for clean surface water application. With built-in check-valve for houses, yards and gardens. Available ready to plug-in, with built-in level control, 1 1/4" or 3/4" NPT discharge.

### F-13 Features

- Completely oil free air filled motor protected by 3 oil seals.
- Built-in thermal motor protector.
- Incorporates a check valve built into the discharge.
- Pump can be operated either manual or automatic.
- 1-1/4" NPT discharge with garden hose adaptor (3/4").
- Easy grip handle design.
- 1 year warranty.

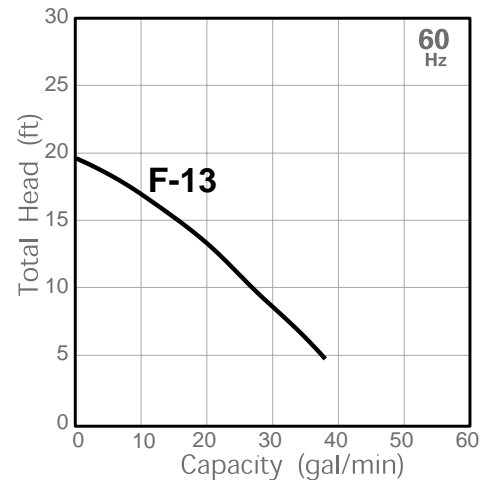

Model	Max. Capacity (GPM)	Max. Head (ft)	Discharge Size (in) - Internal Thread	Nominal HP	RPM	Rated Current at 115V (amps)	Standard Cable Length (ft)	Shipping Weight (lbs.)
F-13	1-1/4	19	3/4	1/4	3450	4.2	10	11

## L4000 SERIES DC PUMP

Designed to meet and exceed the tough demands of commercial and recreational duty.



### L4000 Features

- 1 1/2" and 2" Discharge Ports
- Liquid Cooled Motor
- Universal Mounting Base
- Double-Ball Bearing 12 Pole Motor
- Mechanical Shaft Seal
- Salt Water Tough
- 1 year warranty

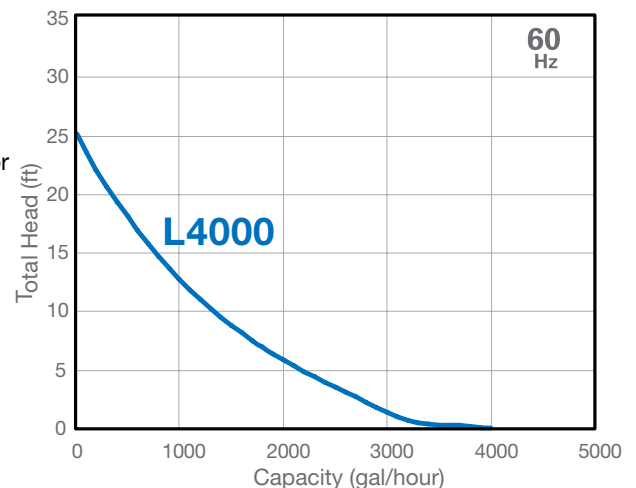

Model	Max. Capacity (GPH)	Max. Head (ft)	Body Material	Discharge Size (in) & Parts Material	Impeller	Shaft Seal	Voltage (V)	Standard Cable Length (ft)	Shipping Weight (lbs.)
L-4000	4000	25	High Impact ABS Thermo-Plastic	1-1/2 & 2 Polypropylene	Glass/Nylon Composite	Mechanical (Carbon/Ceramic)	12	6	5.4

# Electric Submersible Pumps

## LH LHW THREE PHASE SLIMLINE PUMP

### Fits in an 8 inch pipe!

Tsurumi introduces an ultra-slim pump with very high head that fits inside an 8 inch pipe. Ideal for deep-well pre-dewatering.

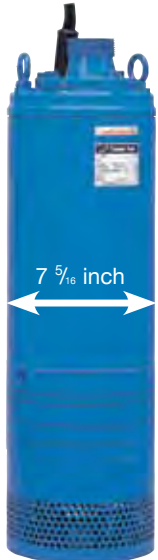

LH23.0W

#### LH LHW Slimline Features

- 1** Circle Thermal Motor Protector: Protects against, overheating over amperage & run-dry.
- 2** Anti-Wicking Block: Prevents water incursion due to capillary wicking, should the power cable be damaged or the end submerged.
- 3** Oil Lifter (Patented): Lubrication of the seal faces down to 1/3 of normal oil level and extends seal life by ten times—uses no additional power.
- 4** Dual Inside Mechanical Seal with Silicon Carbide Faces: Provides longer operational life of any seal available.
- 5** Ball Bearings: Permanently Lubricated, Double Shielded, Single Row, Deep Groove, High Temperature C3 Ball Bearings, Rated B-10=60,000 Hrs.
- 6** High Chrome Iron Semi-Open Impeller: Resists wear from abrasive particles.
- 7** Ductile Iron Casing: Resists wear and reduction of performance due to abrasive particles.

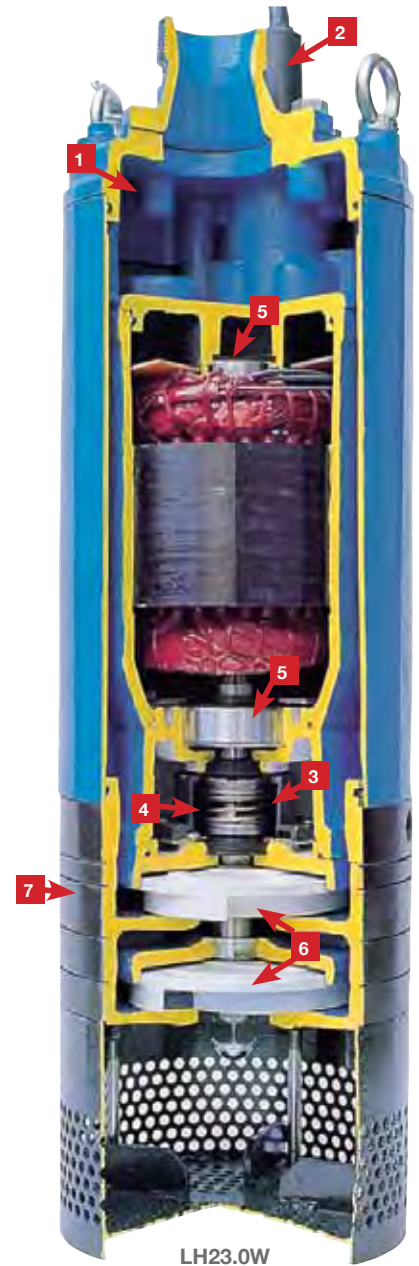

LH23.0W



LH33.0

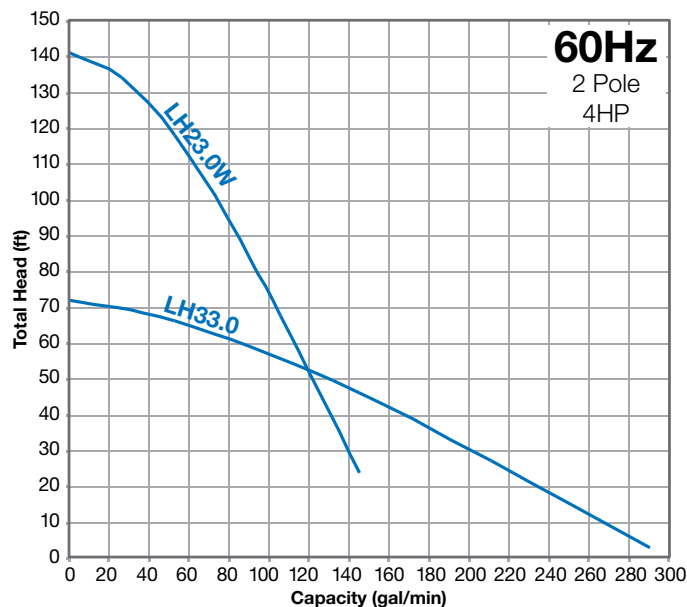

Certified by Intertek Testing Service to UL and CSA standards for submersible construction pumps.

Model	Motor Output (HP)	Phase	Discharge Bore (inch)	Cable Length (ft)	Dimension (inch)		Continuous Running Water Level (inch)	Pump Weight (lbs.)
					Diameter	Height		
LH23.0W	4	Three	2	65	7 5/16	24 13/16	7 7/8	101
LH33.0	4	Three	3	65	7 5/16	25 3/8	5 7/8	93

# Electric Submersible Pumps

## KTZ THREE PHASE DEWATERING PUMPS

Designed to withstand the most demanding conditions found in the construction, aggregate and mining markets. Tsurumi KTZ Series dewatering pump easily converts between high head and high volume performance with a simple change of impeller and wear plate. Wide range of sizes for any job.

### KTZ Series Features

- 1 Circle Thermal Motor Protector: Protects against, overheating over amperage & run-dry.
- 2 Anti-Wicking Block: Prevents water incursion due to capillary wicking, should the power cable be damaged or the end submerged.
- 3 Oil Lifter: Lubrication of the seal faces down to 1/3 of normal oil level and extends seal life by ten times—uses no additional power.
- 4 Dual Inside Mechanical Seal with Silicon Carbide Faces: Provides longer operational life of any seal available.
- 5 Lip Seal Protector: Protects mechanical seal from abrasive particles.
- 6 High Chrome Iron Semi-Open Impeller: Resists wear by abrasive particles.
- 7 Field Adjustable/Replaceable, Ductile Iron Wear Plate: Resists wear by abrasive particles, and is easily adjusted to maintain pump performance.

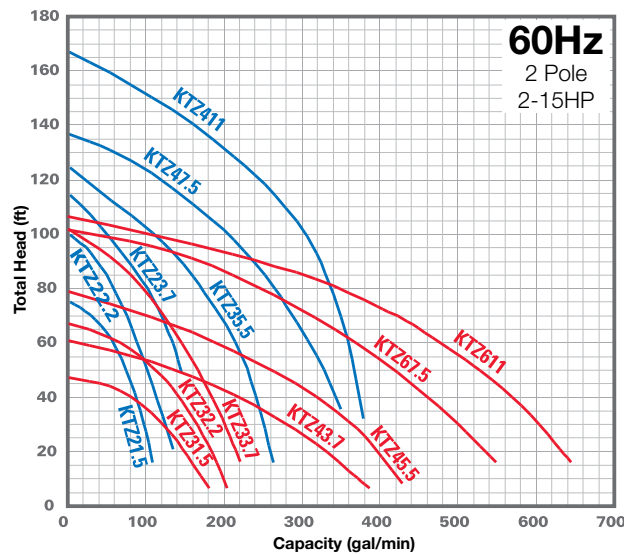
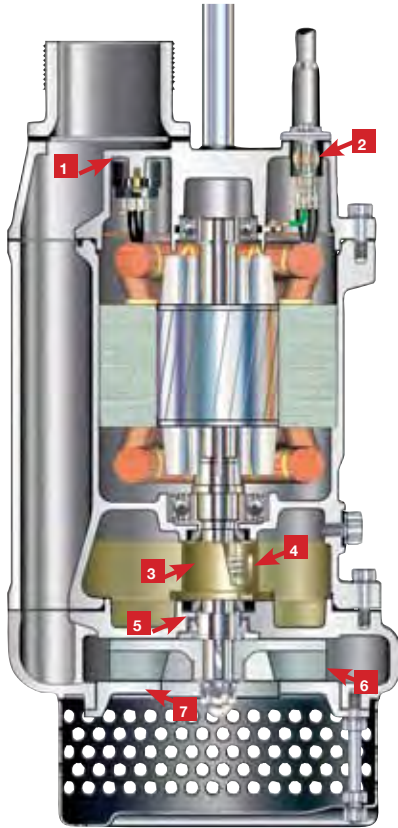

Certified by Intertek Testing Service to UL and CSA standards for submersible construction pumps.

Model	Motor Output (HP)	Phase	Discharge Bore (inch)	Cable Length (ft)	Dimension (inch)		Continuous Running Water Level (inch)	Pump Weight (lbs.)
					Diameter	Height		
KTZ21.5	2	Three	2	50	9 1/4	21 9/16	4 3/4	66
KTZ31.5	2	Three	3	50	9 1/4	21 9/16	4 3/4	66
KTZ22.2	3	Three	2	50	9 1/4	22 3/8	4 3/4	75
KTZ32.2	3	Three	3	50	9 1/4	22 3/8	4 3/4	75
KTZ23.7	5	Three	2	50	11 1/8	25 1/16	5 7/8	139
KTZ33.7	5	Three	3	50	11 1/8	25 1/16	5 7/8	139
KTZ43.7	5	Three	4	50	11 1/8	25 1/16	5 7/8	139
KTZ35.5	7 1/2	Three	3	50	12 1/16	27 1/16	5 7/8	181
KTZ45.5	7 1/2	Three	4	50	12 1/16	27 1/16	5 7/8	181
KTZ47.5	10	Three	4	50	13	28 1/8	7 1/2	231
KTZ67.5	10	Three	4 or *6	50	13	28 1/8 or 30 11/16	7 1/2	236
KTZ411	15	Three	4	50	14 11/16	31 3/4	7 1/2	293
KTZ611	15	Three	4 or *6	50	14 11/16	31 3/4 or 30 3/16	7 1/2	300

\*6 " Discharge Bore for KTZ67.5 & KTZ611 is optional

# Engine Powered Pumps

## **TSURUMI PUMP** Engine Powered Pumps

**TSURUMI Engine Powered Pumps** are constructed for maximum durability in a compact, easy handling design. Utilizing superior features and materials, Tsurumi provides an affordable, high value pump line designed to withstand your tough dewatering applications.

High chrome impeller, cast iron volute casing with stainless steel wear plate provides **increased durability and decreased maintenance** (Trash pumps only).

Durable Rolled-Steel frame provides for a safe, stable platform, **protects pump/engine during operation** and transport, and allows for easy handling.

Silicon Carbide mechanical seal **provides longer life in this class**. Silicon Carbide's high uniform hardness and high density makes it an extremely abrasion resistant material.

Heavy-duty Honda, Subaru gas engine, or Robin Hatz diesel engine **delivers high power** from a compact, reliable design.

Oil Alert System **automatically shuts the engine down** if the oil level falls below the safe operating level.

Rubber Vibration Isolators **insure safe and stable operation**, reduce vibration of structural parts and support the pump casing to reduce hose or pipe strain.

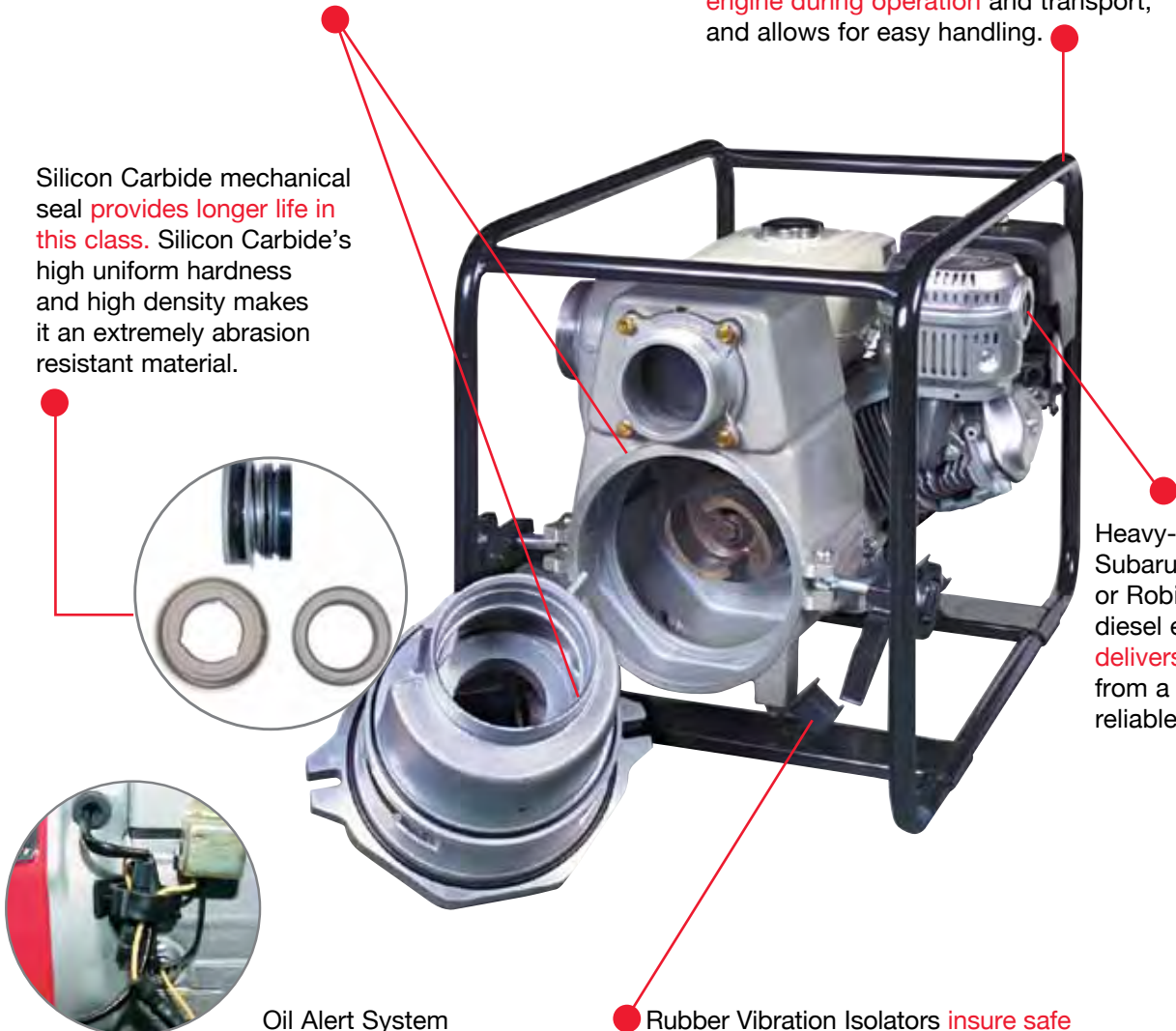

# Engine Powered Pumps

## TE SERIES CENTRIFUGAL PUMPS

### Powerful, Lightweight Pumps

Powered by heavy-duty, powerful **Honda GX series gas engines (TE-HA)**, or **Subaru EX Series gas engines (TE-RX)**.

#### TE2/TE3-HA Gas Engine Centrifugal Pumps *Powered by Honda*

- Heavy-duty Honda gas engine with oil sensor and Silicon Carbide mechanical seal provides longer life in this class.
- Cast Iron impeller and volute casing.
- Durable Rolled-Steel frame provides pump/engine with maximum protection, perfect ease of handling or transport, and safe operation.
- Rubber mounts on the pump and the frame.
- Both 2" and 3" models are light enough for UPS shipment.

#### TE5-RX Gas Engine Centrifugal Pumps *Powered by Subaru*

- Silicon Carbide mechanical seal provides the longest life in this class.
- Two inch economical high performance centrifugal engine pump.
- Extremely silent. Subaru EX Engine is two dBA quieter than competitive models.
- Easy and reliable starting. 30-40% less pulling force than competitive models.
- Rubber mounts on the pump and the frame.
- Low emission level and high capacity Air Cleaner.
- Heavy Duty Chain Drive OHC System.



Honda TE2-100HA



Subaru TE5-80RX

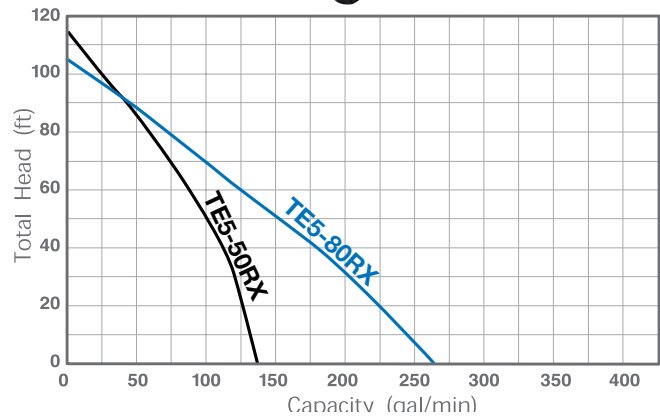
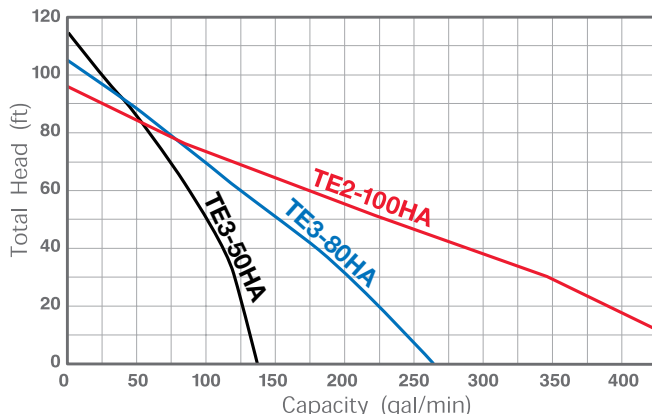

Model	Discharge / Suction Size	Engine	Max. Output (hp/rpm)	Dimensions (inches)			Shipping Weight (lbs.)
				Length	Width	Height	
TE3-50HA	2" NPT Coupling	Honda GX120	4.0 / 3600	18 1/2	14 5/8	17 1/8	55
TE3-80HA	3" NPT Coupling	Honda GX160	5.5 / 3600	20 1/2	16 1/2	18 1/8	64
TE2-100HA	4" NPT Coupling	Honda GX240	8.0 / 3600	25	18	23 1/2	109
TE5-50RX	2" NPT Coupling	Subaru EX16	4.5 / 4000	20 1/2	16 1/2	18 7/8	60
TE5-80RX	3" NPT Coupling	Subaru EX17	6.0 / 4000	20 1/2	16 1/2	18 7/8	64

# Engine Powered Pumps

## TE2-25HA CENTRIFUGAL PUMP

### Compact and Lightweight

TSURUMI PUMP Model TE2-25HA is ideal for general dewatering, irrigation and all-purpose cleaning and wash down applications. Easy starting and quiet running is assured with its four stroke Honda GX25 engine. Built to be lightweight yet durable.

#### TE2-25H Centrifugal Pumps Powered by Honda



- Heavy-duty Honda gas engine with oil sensor and Silicon Carbide mechanical seal provides longer life in it's class.
- Cast Iron impeller and volute casing.
- Durable Rolled-Steel handle for ease of handling.

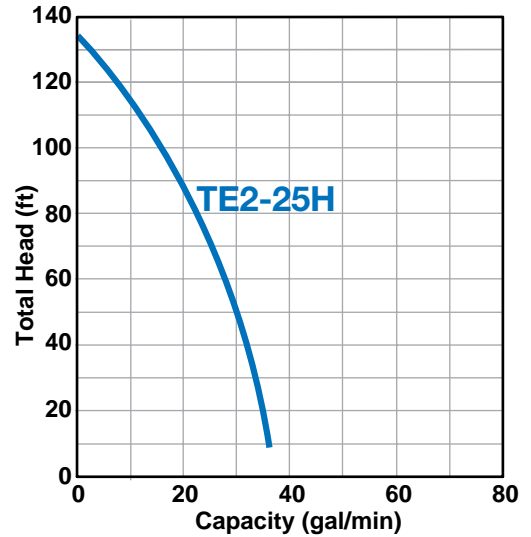

Model	Suction Size	Engine	Max. Output (hp/rpm)	Dimensions (inches)			Shipping Weight (lbs.)
				Length	Width	Height	
TE2-25H	1" NPT Coupling	Honda GX25	1.1 / 2220	9	14	13	12

## TE2-RDB CENTRIFUGAL PUMPS

Lightweight dependable dewatering pumps powered by Robin Hatz diesel Engine.

#### TE2-RDB Centrifugal Pumps Powered by Robin Hatz



- Heavy-duty Robin Hatz Diesel Engine
- Low emission level for cleaner environment
- Silicon carbide mechanical seals
- Cast iron volute casting
- Durable rolled-steel frame

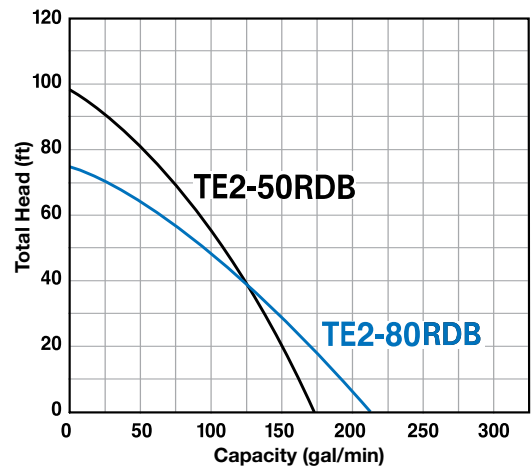

Model	Suction Size	Engine	Max. Output (hp/rpm)	Dimensions (inches)			Shipping Weight (lbs.)
				Length	Width	Height	
TE2-50RDB	2" NPT Coupling	Robin Hatz 1B20	4.9 / 3600	24 13/16	17 15/16	22 1/4	95
TE2-80RDB	3" NPT Coupling	Robin Hatz 1B30	4.9 / 3600	24 13/16	17 15/16	22 1/4	97



# Engine Powered Pumps

## EPT SERIES GAS ENGINE TRASH PUMPS

### Powerful Trash Handling Pumps of Highest Quality



- 1** The clean-out door can be disassembled easily without taking off suction hose.
- 2** Designed with larger pump casing.
- 3** Heavy-duty Honda gas engine.
- 4** Mounted to cage frame on Rubber Vibration Cushions.
- 5** Durable rolled-steel frame.
- 6** High Chrome impeller, cast Iron volute casing, stainless steel wear plate, and galvanized Steel hose couplings.



Engine Driven Trash Pump  
powered by Honda  
EPT3-50HA



Engine Driven Trash Pump  
powered by Subaru  
EPT3-80RX



Engine Driven Trash Pump  
powered by Robin Hatz  
EPT2-100RDB

# Engine Powered Pumps

## EPT3 SERIES ENGINE TRASH PUMPS

We have redesigned our portable trash pump series by increasing the size of the pump casing. Plus, we have installed an access door to the impeller that can be take off the volute casing without you having to remove the suction hose. **Powered by quality, dependable Honda and Subaru gas engines.**

### EPT3-HA Gas Engine Trash Pumps *Powered by Honda*

- Heavy-duty Honda gas engine with oil sensor delivers high power from a compact, reliable design. Silicon Carbide mechanical seal provides longer life in this class.
- High Chrome impeller, Cast Iron volute casing plus Stainless Steel wear plate promise increased durability and decreased maintenance.
- Pump/engine set mounted to cage frame on Rubber Vibration Cushions to buffer stress and wear.
- Durable Rolled-Steel frame provides pump/engine with maximum protection, perfect ease of handling or transport and safe operation.
- Galvanized Steel hose couplings promise longer thread life.
- Carrying Handle/Wheel Kit and Lifting Bail for easy transportation available with all trash pumps as an optional accessory.



Honda  
EPT3-50HA



Subaru  
EPT3-50RX

### EPT3-RX Gas Engine Trash Pumps *Powered by Subaru*

- Extremely Silent. Subaru EX gas Engine is two dB quieter than competitive models.
- Low emission level for cleaner environment.
- High capacity Air Cleaner.
- Heavy Duty Chain Drive OHC System.
- Easy and reliable starting requires 30-40% less pulling force than competitive models.
- High Chrome impeller, Cast Iron volute casing plus Stainless Steel wear plate promises increased durability and decreased maintenance.
- Pump/engine set mounted to cage frame on Rubber Vibration Cushions to buffer stress and wear.
- Durable Rolled-Steel frame provides pump/engine with maximum protection, perfect ease of handling or transport, and safe operation.
- Galvanized Steel hose couplings promise longer thread life.

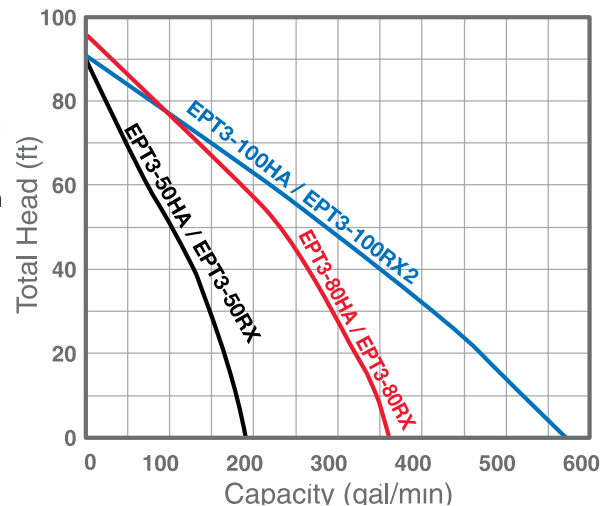

Model	Discharge / Suction Size	Engine	Max. Output (hp/rpm)	Dimensions (inches)			Shipping Weight (lbs.)
				Length	Width	Height	
EPT3-50HA	2" NPT Coupling	Honda GX160	5.5 / 3600	23 1/4	18 1/4	17 3/8	82
EPT3-80HA	3" NPT Coupling	Honda GX240	8.0 / 3600	27 1/2	20 1/8	25 5/8	136
EPT3-100HA	4" NPT Coupling	Honda GX340	11.0 / 3600	30 1/8	20 1/8	26	160
EPT3-50RX	2" NPT Coupling	Subaru EX17	6.0 / 4000	23 1/4	18 1/4	17 3/8	82
EPT3-80RX	3" NPT Coupling	Subaru EX27	7.0 / 4000	27 1/2	20 1/8	25 5/8	136
EPT3-100RX2	4" NPT Coupling	Subaru EX35	12.0 / 3600	30 1/8	20 1/8	26	163

# Engine Powered Pumps

## EPT2-RDB DIESEL ENGINE PUMPS

Powered by quality, dependable Robin Hatz Diesel engine. Built with the highest quality components for use on your toughest dewatering jobs.

### EPT2-RDB Diesel Engine Trash Pumps

Powered by Robin Hatz

- Heavy-duty Robin Hatz Diesel Engine
- Low emission level for cleaner environment
- Silicon carbide mechanical seals
- Extremely quiet
- High capacity Air Cleaner
- Easy and reliable starting
- High chrome impeller
- Cast iron volute casting plus stainless steel wear plate
- Pump / engine set mounted to cage frame on rubber vibration cushions
- Durable rolled-steel frame
- Galvanized steel hose couplings

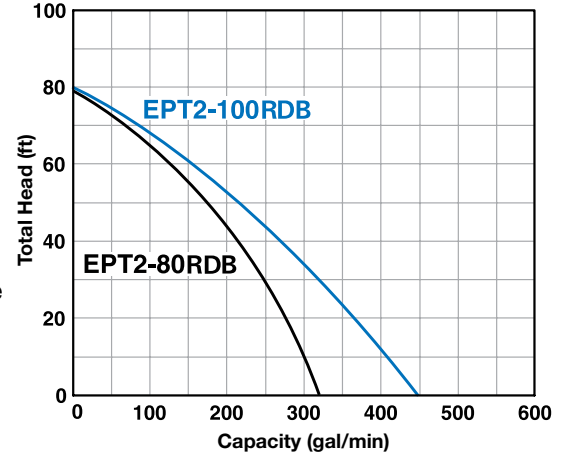

Model	Discharge / Suction Size	Engine	Max. Output (hp/rpm)	Dimensions (inches)			Shipping Weight (lbs.)
				Length	Width	Height	
EPT2-80RDB	3" NPT Coupling	Robin Hatz 1B30	6.8 / 3600	26	19	24	128
EPT2-100RDB	4" NPT Coupling	Robin Hatz 1B40	9.9 / 3600	26	19	26	193

## THP HIGH PRESSURE PUMP

### High Pressure and High Performance

A pump for sprinkling, irrigation and fire protection.

#### THP4070-HA Features

- Heavy-duty Honda gas engine with oil sensor and Silicon Carbide mechanical seal provides longer life in this class.
- Maximum pressure of 100 PSI for high pressure applications.
- Versatile 3-way discharge allows pump to run up to three discharge lines simultaneously. Two 1" couplings and one 1 1/2" coupling.
- High head, closed impeller and cast iron volute casing deliver high performance and long wear life.

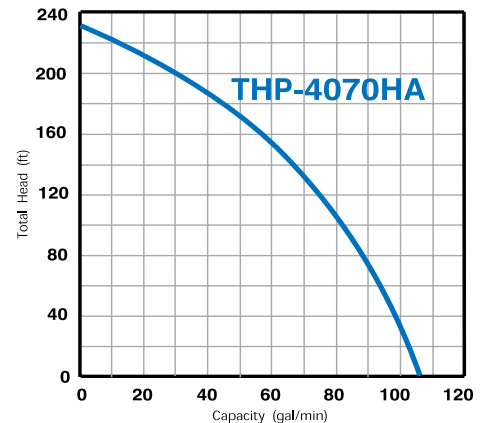

Model	Discharge Size	Suction Size	Engine	Max. Output (hp/rpm)	Dimensions (inches)			Shipping Weight (lbs.)
					Length	Width	Height	
THP-4070HA	1" x 2, 1.5" x 1 NPT Coupling	1.5" NPT Coupling	Honda GX160	5.5 / 3600	21	16	18	62

# Engine Powered Pumps

## TD5 DIAPHRAGM PUMPS

### Powerful Sand, Mud and Sludge Handling Pumps

Capable of continuous dry operation for seepage dewatering. Handles sand, mud and sludge.



#### TD5 Diaphragm Pumps Features

- Sand Cast Aluminum Construction for Portability and Durability
- Thermoplastic Rubber Diaphragm
- 2" or 3" NPT Suction and Discharge Size
- 1-5/8" Diameter Solids Handling Capability
- Modular Component design permits easy maintenance and cleanout
- Engine Driven Model: Honda GX120
- Delivers up to 90 GPM
- Maximum Temperature 180°F

90°rotatable base on both models

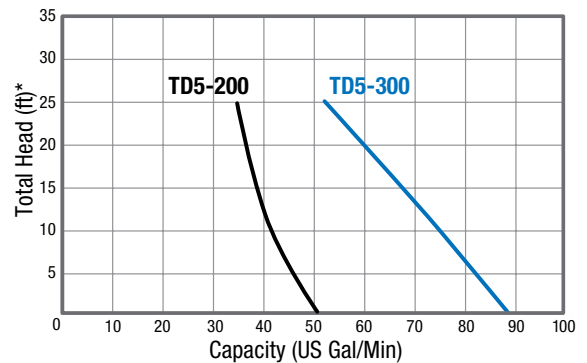

Model	Discharge / Suction Size (inches)	Engine	Max. Output (hp/rpm)	Dimensions (inches)			Shipping Weight (lbs.)
				Length	Width	Height	
TD5-200	2" NPT Coupling	Honda GX120	4 / 3600	39	26	23	167
TD5-300	3" NPT Coupling	Honda GX120	4 / 3600	42	30	22	175

## EPT5 SERIES GAS / DIESEL TRASH PUMP

### Industrial Duty 6" Trash Pump: Powered by Honda gas engine / Yanmar diesel engine

#### EPT5-150HA (Gas Engine) / EPT5-150YD (Diesel Engine) Trash Pump Features



- Cast Aluminum Casing and Adapter
- Cast Iron Wear Plate, Volute and Manifold
- Stainless Steel Impeller
- Silicon Carbide Mechanical Seal and Buna O-Rings and Flapper / Check Valve
- 6" NPT Port Size
- Self Priming to 20ft
- Available with Honda GX670 Gas Engine or Yanmar 3TNM72 Diesel Engine
- Solids Handling to 3" Diameter
- Unique Slide Mechanism permits complete service of pump without removing hoses or removing pump components from trailer (Patent Pending)
- Includes Seal Wash Feature for extended seal life
- 12 VDC Electric Start; Digital Tachometer / hourmeter included
- D.O.T. Approved Trailer - See your state and local codes for registration

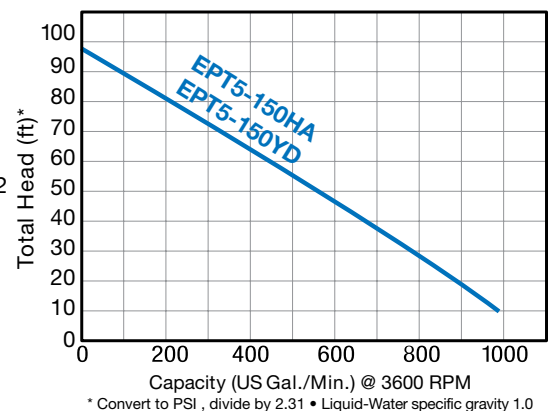

Model	Discharge Suction Size (inches)	Engine Type	Engine	Max. Output (hp/rpm)	Dimensions (inches)			Shipping Weight (lbs.)
					Length	Width	Height	
ETP5-150HA	6" NPT Coupling	Unleaded Gasoline	Honda GX670	22.0 / 3600	99	48	60	1125
EPT5-150YD	6" NPT Coupling	Diesel	Yanmar 3TNM72	22.8 / 3600	99	48	60	1250

# Engine Powered Pumps

## EPT4-150 HEAVY DUTY TRASH PUMP

### Heavy Duty Prime Assisted & Sound Attenuated Priming Assisted Trash Pump



Priming Assisted: EPT4-150DPJD



Sound Attenuated Priming Assisted: EPT4-150DPQJD

#### EPT4-150DPJD / EPT4-150DPQJD Features powered by John Deere

- Vacuum assisted pump that primes and re-primed by use of a compressor running high pressure air across a venturi which creates a vacuum
- Heavy-duty John Deere diesel engine, water cooled, Model 4045TF290
- With electric start and 60 gallon fuel tank for a runtime at full of load of 24 hours.
- Passes 3" spherical solids
- Mechanical seal is tungsten and silicon carbide seal faces, viton elastomers, 303 stainless steel hardware and spring. Seal system designed for dry running.
- Heavy duty road trailer

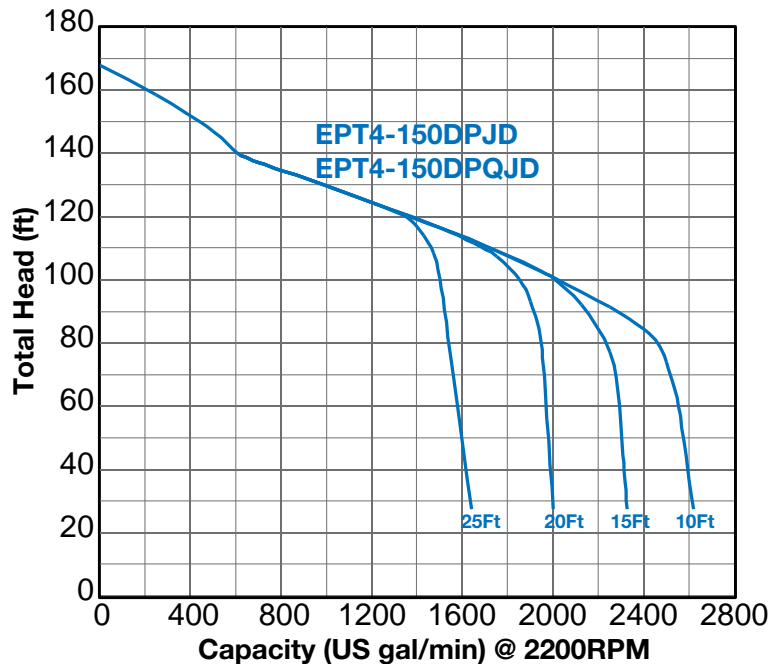

Model	Discharge / Suction Size (inches)	Engine	Max. Output (hp/rpm)	Dimensions (inches)			Shipping Weight (lbs.)
				Length	Width	Height	
EPT4-150DPJD	6" ANSI Flange	John Deere 4045TF290	74 / 2200	136 1/2	67	67 7/8	3360
EPT4-150DPQJD	6" ANSI Flange	John Deere 4045TF290	74 / 2200	161 1/2	76 1/8	79 13/16	4800

# Engine Powered Pumps

## EPT2-100DD/150DD TRASH PUMP

### Trailer Mounted Trash Pumps for Tough Jobs

Dewatering to sewage, clean water to 3-inch solids—our trash pumps do it all.

#### EPT2-100DD / EPT2-150DD Diesel Trash Pump

Features powered by Deutz



- Heavy-duty Deutz diesel engine with electric start
- Pass 3" solids (EPT2-150DD) or 2" solids (EPT2-100DD) with non-clog, wear resistant ductile iron impeller on 304 stainless steel shaft sleeve.
- Oil and abrasion resistant, rubber-lined front and rear wear plates.
- Long-life grease lubricated tungsten carbide mechanical seals (optional oil lubricated seals available).
- Heavy-duty DOT road trailer with 15" 6-ply tires and 2" pintle hitch.

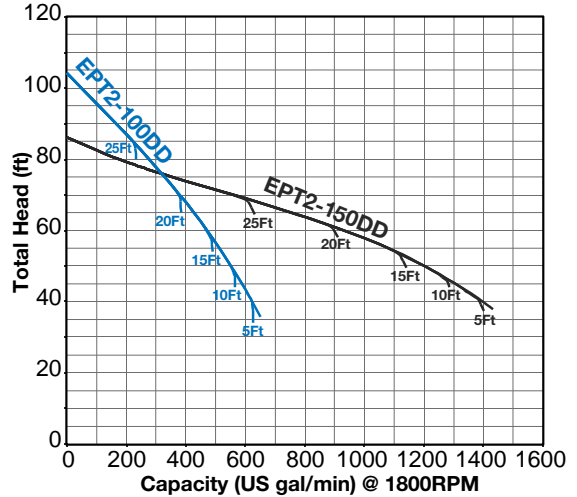

Model	Discharge / Suction Size	Engine	Max. Output (hp/rpm)	Dimensions (inches)			Shipping Weight (lbs.)
				Length	Width	Height	
EPT2-100DD	4" NPT Coupling	Deutz 2011L02I	20 / 1800	106 1/8	65 1/2	70	1960
EPT2-150DD	6" NPT Coupling	Deutz 2011L03I	30 / 1800	112 3/4	65 1/2	70	2223

## EPT3-150YD TRASH PUMP

### Powerful 6-Inch Self-Priming Trash Pump

#### EPT3-150YD Diesel Trash Pump Features powered by Yanmar



- Powered by a heavy-duty water cooled Yanmar diesel engine - Model 3TNV88 featuring low emissions, noise, vibration, and lower fuel consumption.
- Capable of passing 3" solids and is designed for rugged applications in rental, construction, civil engineering, industrial, wastewater and agricultural applications.
- Constructed with a class 30 cast iron casing, two vane ductile iron impeller and replaceable ductile iron volute.
- Heavy duty DOT road trailer with 15" 6-ply tires and 2" ball hitch (optional pintle hitch available).

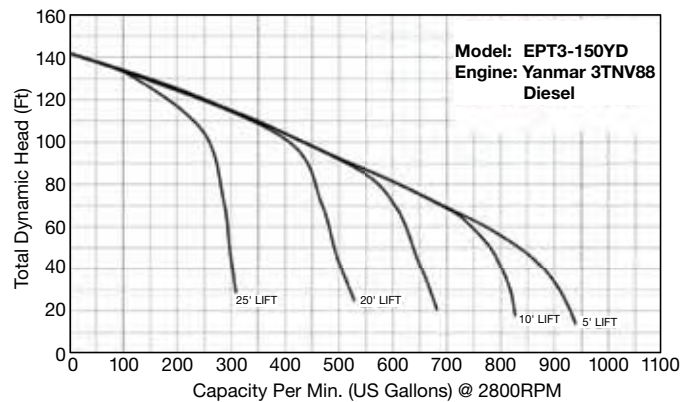

Model	Discharge / Suction Size (inches)	Engine	Max. Output (hp/rpm)	Dimensions (inches)			Shipping Weight (lbs.)
				Length	Width	Height	
EPT3-150YD	6 NPT male	Yanmar 3TNV88D	33 / 2800	108	60	69	1750

# Electric Submersible Pumps Specifications

## LB Series • HS Series

		LB-480	LB-480A	LB-800	LB-800A	LB-1500	HS2.4S	HS3.75S	HSZ2.4S	HSZ3.75S	HSD2.55S
		Dewatering	Automatic Operation	Slimline Pump	Slimline Pump w/ Automatic Operation	Slimline Pump	Sand/Solids Trash Pump	Sand/Solids Trash Pump	Automatic Trash Pump	Automatic Trash Pump	Extreme Durable Sand Pump
FLUID	Max. Capacity (GPM)	62.4	62.4	82	82	111	53	60	53	60	58
	Max. Head (ft.)	39.5	39.5	59	59	69	39	62	39	62	43
	Solid Diameter (inches)	1/4	1/4	1/4	1/4	5/8	1/4	1/4	1/4	1/4	3/8
PUMP		Semi-Vortex				Semi-Open	Semi-Vortex				
	Impeller Material	Urethane Rubber				High Chrome	Urethane Rubber				High Chromium
	Casing Material	Ethylene Propylene Rubber	Butadiene Rubber and Natural Rubber			Butadiene Rubber, Natural Rubber & Steel	Grey Iron Casting				Ductile Iron Casting
	Wear Plate Material	Urethane Rubber				Natural Rubber	Integral Part of Casting				
	Shaft Seal - Type / Material	Double inside mechanical seal with Silicon Carbide									
	Seal Lubricant - Type	SAE 10W/20W or Turbine Oil (ISO VG32)									
	Seal Lubricant - Amount (ounces)	5.2	5.2	5.2	5.2	12.5	5.4	5.4	5.4	5.4	5.4
	Seal Protection	V-Ring and Oil Lifter (Oil Lifter is patented by Tsurumi Pump)									
	Discharge Connection	2" NPT Coupling	2" NPT Coupling	2" NPT Coupling	2" NPT Coupling	3" NPT Coupling (2" is optional)	2" NPT Coupling	3" NPT Coupling	2" NPT Coupling	3" NPT Coupling	2" NPT Coupling
	MOTOR	Motor Output (hp)	2/3	2/3	1	1	2	1/2	1	1/2	1
Phase		Single									
Voltage (V)		110 or 220	110 or 220	115 or 230	115 or 230	115 or 230	110 or 220	115 or 230	110 or 220	115 or 230	115
Amperage - Rated Current		6.1 (110V) 3.0 (220V)	6.1 (110V) 3.0 (220V)	9.6 (115V) 5.1 (230V)	9.6 (115V) 5.1 (230V)	26.2 (115V) 13.2 (230V)	5.4 (110V) 2.7 (220V)	9.6 (115V) 4.6 (230V)	5.4 (110V) 2.7 (220V)	9.6 (115V) 4.6 (230V)	7.5
Amperage - Starting Current		12.6 (110V) 6.3 (220V)	12.6 (110V) 6.3 (220V)	40.4 (115V) 21.2 (230V)	40.4 (115V) 21.2 (230V)	112 (115V) 56 (230V)	12.6 (110V) 6.3 (220V)	26 (115V) 13.5 (230V)	12.6 (110V) 6.3 (220V)	26 (115V) 13.5 (230V)	22.2
Type		Continuous duty, Air filled, 3600RPM, 60Hz									
Bearings		Double shielded, Permanentary lubricated, High-temp C3 with B-10 life of 60,000 hours									
Insulation Class		E	E	E	E	B	E	E	E	E	E
Motor Protection (Built-In)		Miniature Protector		Circle Thermal Protector			Miniature Protector				
Plug Configuration (Nema)		5-15P (110V) No Plug (220V)	5-15P (110V) No Plug (220V)	5-15P (115V) No Plug (230V)	5-15P (115V) No Plug (230V)	No Plug	5-15P (110V) No Plug (220V)	5-15P (115V) No Plug (230V)	5-15P (110V) No Plug (220V)	5-15P (115V) No Plug (230V)	5-15P
Cable - #of Conductors x AWG		3Cx16AWG	3Cx16AWG	3Cx14AWG	3Cx14AWG	3Cx12AWG (110V) 3Cx14AWG (230V)	3Cx16AWG	3Cx14AWG	3Cx16AWG	3Cx14AWG	3Cx16AWG
Standard Cable		32	32	50	50	50	20	32	20	32	32
Max. Cable Length (ft.)		83 (110V) 338 (220V)	83 (110V) 338 (220V)	55(110V) 190 (230V)	55(110V) 190 (230V)	62(110V) 185 (230V)	94 (110V) 376 (220V)	88 (115V) 369 (230V)	94 (110V) 376 (220V)	94 (115V) 376 (230V)	71
Recommended Generator Capacity		2700	2700	4600	4600	8400	2400	3700	2400	3700	2900
Optional Float Switch	TS-302 (110V) TS-303 (220V)	N/A	TS-302 (115V) TS-303 (230V)	TS-302 (115V) TS-303 (230V)	TS-303 (230V operation only)	TS-302 (110V) TS-303 (220V)	TS-302 (115V) TS-303 (230V)	N/A	N/A	TS-301	
DIMENSION	Diameter (inches)	7 3/8	8 3/4	7 9/16	8 3/4	7 3/8	10 1/16	12 7/16	13 1/2	13 1/2	9 3/4
	Height (inches)	11 1/4	11 1/4	13 7/16	13 7/16	23 5/16	12 15/16	15 1/4	15 1/8	17 1/2	15 3/8
	Continuous Running Water Level (in.)	2	4 1/2 (Pump Starting Water Level)	2	6 3/4 (Pump Starting Water Level)	3 1/8	3 1/2	3 1/2	15 1/8 (Pump Starting Water Level)	17 1/2 (Pump Starting Water Level)	4 1/8
	Shipping Weights (lbs.)	28	30	35	38	85	30	49	30	49	36

# Electric Submersible Pumps Specifications

## LSR Series • LSC Series • NK Series • LBT Series • LH Series

		LSR2.4S	LSC1.4S	NK2-15	NK2-22	NK2-22L	LBT-800	LBT-1500	LH23.0W	LH33.0	
		Ground Level	Floor Level	Heavy Duty & High Head	Heavy Duty & High Head	Heavy Duty & High Flow	3-Phase Slimline Pump	3-Phase Slimline Pump	3-Phase Slimline Pump	3-Phase Slimline Pump	
FLUID	Max. Capacity (GPM)	62.4	45	111	130	211	82	111	145	291	
	Max. Head (ft.)	39.5	39	69	85	59	59	69	141	72	
	Solid Diameter (inches)	0.236	0.236	5/16	5/16	5/16	1/4	1/4	1/4	1/4	
PUMP	Impeller Type	Semi-Vortex				Semi-Open	Semi-Vortex	Semi-Open	Closed		
	Impeller Material	Urethane Rubber		Ductile Iron Casting		High Chrome	Urethane Rubber		High-Chrome Cast Iron		
	Casing Material	Ethylene Propylene Rubber				Cast Iron	Natural Rubber		Ductile Cast Iron		
	Wear Plate Material	Urethane Rubber		Integral Part of Casting		Ductile Iron Casting	Natural Rubber		Integral Part of Casting		
	Shaft Seal - Type / Material	Double inside mechanical seal with Silicon Carbide									
	Seal Lubricant - Type	SAE 10W/20W or Turbine Oil (ISO VG32)									
	Seal Lubricant - Amount (ounces)	6.1	6.1	9.1	9.1	9.1	5.2	12.5	13.8	13.8	
	Seal Protection	V-Ring and Oil Lifter (Oil Lifter is patented by Tsurumi Pump)							Oil Lifter (Patented by Tsurumi)		
	Discharge Connection	2" NPT Coupling	3/4" NPT Coupling	3" NPT Coupling	3" NPT Coupling	3" NPT Coupling	2" NPT Coupling	3" NPT Coupling (2" is optional)	2" NPT Coupling	3" NPT Coupling	
	MOTOR	Motor Output (hp)	2/3	2/3	2	3	3	1	2	4	4
Phase		Single				Three					
Voltage (V)		110	110	110 / 220	220	220	208-230 /460/575	208-230 /460/575	208-230 /460/575	208-230 /460/575	
Amperage - Rated Current		6.1	6.1	23.0/11.5	13	13	3.4-3.2/ 1.6/1.2	7.2-8.0/ 4.0/2.9	12.3-12.0/ 6.0/4.7	12.3-12.0/ 6.0/4.7	
Amperage - Starting Current		12.5	12.5	136/68	70.0	70.0	19.4/9.7/7.0	42/21/14	86.1-84/ 48.6/35.3	86.1-84/ 48.6/35.3	
Type		Continuous duty, Air filled, 3600RPM, 60Hz									
Bearings		Double shielded, Permanentary lubricated									
Insulation Class		E	E	B	B	B	E	E	F	F	
Motor Protection (Built-In)		Miniature Protector			Circle Thermal Protector						
Plug Configuration (Nema)		5-15P	5-15P	No Plug							
Cable - #of Conductors x AWG		3Cx16AWG	3Cx16AWG	3Cx12AWG	3Cx14AWG	3Cx14AWG	4Cx16AWG	4Cx16AWG	4Cx14AWG	4Cx14AWG	
Standard Cable		32	20	32	32	32	50	50	64	64	
Max. Cable Length (ft.)		62	62	46 (110V) 185 (220V)	94	94	192(230V) 766 (460V) 1276 (575V)	77(230V) 306 (460V) 528 (575V)	220(208-230V) 813 (460V) 302 (575V)	220(208-230V) 813 (460V) 302 (575V)	
Recommended Generator Capacity		2700	2700	7200	10000	10000	3600	7400	14200	14200	
Optional Float Switch		TS-301	N/A	TS-303 (220V Operation Only)				Control Panel			
DIMENSION	Diameter (inches)	8 1/4	7 11/16	9 7/16	9 7/16	9 1/4	7 9/16	7 3/8	7 5/16	7 5/16	
	Height (inches)	11 3/8	12 7/16	24 1/2	24 1/2	26 1/2	13 7/16	23 5/16	24 13/16	25 3/8	
	Continuous Running Water Level (in.)	0.20	0.04	3 1/4	3 1/4	4 3/4	2	3 1/8	7 7/8	5 7/8	
	Shipping Weights (lbs.)	28	29	80	78	84	35	85	121	111	



# Electric Submersible Pumps Specifications

## KTZ Series

		KTZ21.5	KTZ22.2	KTZ23.7	KTZ31.5	KTZ32.2	KTZ33.7	KTZ35.5	KTZ43.7	KTZ45.5	KTZ47.5	KTZ411	KTZ67.5	KTZ611	
		Water Resistant Pumps													
FLUID	Max. Capacity (GPM)	106	132	143	180	203	219	260	386	428	349	377	549	645	
	Max. Head (ft.)	75	100	115	47	67	102	125	61	79	137	167	102	107	
	Solid Diameter (inches)	5/16											13/16		
PUMP	Impeller Type	Semi-Open													
	Impeller Material	High Chrome													
	Casing Material	Cast Iron													
	Wear Plate Material	Ductile Cast Iron													
	Shaft Seal - Type / Material	Double inside mechanical seal with Silicon Carbide													
	Seal Lubricant - Type	SAE 10W/20W or Turbine Oil (ISO VG32)													
	Seal Lubricant - Amount (ounces)	25.0	25.0	40.6	25.0	25.0	40.6	37.2	40.6	37.2	25.7	25.7	25.7	25.7	25.7
Seal Protection	Lip Seal and Oil Lifter (Oil Lifter is patented by Tsurumi Pump)														
Discharge Connection	2" NPT Coupling			3" NPT Coupling				4" NPT Coupling				4" NPT Coupling (6" is optional)			
MOTOR	Motor Output (hp)	2	3	5	2	3	5	7.5	5	7.5	10	15	10	15	
	Phase	Three													
	Voltage (V)	208-230 / 460 / 575													
	Amperage - Rated Current	6.2-6.0/3.1/2.3	9.4-9.0/4.5/3.5	15.0-13.6/6.8/5.3	6.2-6.0/3.1/2.3	9.4-9.0/4.5/3.5	15.0-13.6/6.8/5.3	21.0-20.0/10.0/7.9	15.0-13.6/6.8/5.3	21.0-20.0/10.0/7.9	28.8-26.6/13.3/10.4	40.0-37.6/18.6/14.9	28.8-26.6/13.3/10.4	40.0-37.6/18.6/14.9	
	Amperage - Starting Current	44/22/16	46/38/28	120/60/43	44/22/16	46/38/28	120/60/43	170/85/62	120/60/43	170/85/62	236/118/85	310/155/120	236/118/85	310/155/120	
	Type	Continuous duty, Air filled, 3600RPM, 60Hz													
	Bearings	Double shielded, permanentary lubricated													
	Insulation Class	F													
	Motor Protection (Built-In)	Circle Thermal Protector													
	Plug Configuration (Nema)	No Plug													
Cable - #of Conductors x AWG	4Cx16AWG	4Cx16AWG	4Cx14AWG	4Cx16AWG	4Cx16AWG	4Cx14AWG	4Cx12AWG	4Cx14AWG	4Cx12AWG	4Cx10AWG	4Cx8AWG	4Cx10AWG	4Cx8AWG		
Standard Cable Length (ft.)	50														
Max. Cable Length (ft.)	130 (230V) 610 (460V) 670 (575V)	90 (230V) 400 (460V) 440 (575V)	90 (230V) 450 (460V) 460 (575V)	130 (230V) 610 (460V) 670 (575V)	90 (230V) 400 (460V) 440 (575V)	90 (230V) 450 (460V) 460 (575V)	110 (230V) 540 (460V) 590 (575V)	90 (230V) 450 (460V) 460 (575V)	110 (230V) 540 (460V) 590 (575V)	130 (230V) 650 (460V) 690 (575V)	130 (230V) 650 (460V) 690 (575V)	130 (230V) 650 (460V) 690 (575V)	130 (230V) 650 (460V) 690 (575V)		
Recommended Generator Capacity	8800	12400	19100	8800	12400	19100	27600	19100	27600	38300	53700	38300	53700		
Optional Float Switch	N/A														
DIMENSION	Diameter (inches)	9 1/4	9 1/4	11 1/8	9 1/4	9 1/4	11 1/8	12 1/16	11 1/8	12 1/16	13	14 11/16	13	14 11/16	
	Height (inches)	21 9/16	22 3/8	25 1/16	21 9/16	22 3/8	25 1/16	27 1/16	25 1/16	27 1/16	28 1/8	31 3/4	28 1/8 or 30 11/16	31 3/4 or 30 3/16	
	Continuous Running Water Level (in.)	4 3/4	4 3/4	5 7/8	4 3/4	4 3/4	5 7/8	5 7/8	5 7/8	5 7/8	7 1/2	7 1/2	7 1/2	7 1/2	
	Pump Weight (lbs.)	66	75	139	66	75	139	181	139	181	231	293	236	300	

# Engine Powered Pumps Specifications

TE2-25HA • TE3-50HA - 100HA • TE5-50RX - 80RX

TE2-50RDB - 80RDB • EPT2-80RDB - 100RDB • EPT3-50HA - 100HA

	TE2-25H 1" Dewatering Pump	TE3-50HA 2" Dewatering Pump	TE3-80HA 3" Dewatering Pump	TE2-100HA 4" Dewatering Pump	TE5-50RX 2" Dewatering Pump	TE5-80RX 3" Dewatering Pump	TE2-50RDB 2" Dewatering Pump	TE2-80RDB 3" Dewatering Pump	EPT2-80RDB 3" Trash Pump	EPT2-100RDB 4" Trash Pump	EPT3-50HA 2" Trash Pump	EPT3-80HA 3" Trash Pump	EPT3-100HA 4" Trash Pump	
<b>FLUID</b>	Max. Capacity (GPM)	37	137	264	476	137	264	172	212	317	449	190	360	570
	Max. Capacity (GPH)	2220	8220	15840	28560	8220	15840	10320	12720	19020	26940	11400	21600	34200
	Max. Head (ft.)	109	115	105	92	115	105	98	75	79	79	90	96	91
	Max. Solid Diameter (inches)	0	3/8						1 1/2		1	1 1/2		
<b>PUMP</b>	Impeller Type	Semi-Open												
	Impeller (Diaphragm) Material	Cast Iron						High Chrome Iron Casting						
	Volute Casting Material	Cast Iron												
	Wear Plate Material	Integral Part of Volute										Stainless Steel		
	Pump Casing Material	Die Cast Aluminum										Cast Aluminum		
	Shaft Seal - Type / Material	Silicon Carbide Mechanical Seal												
	Seal Lubricant - Type	Water												
	Discharge Connection	1" NPT Coupling	2" NPT Coupling	3" NPT Coupling	4" NPT Coupling	2" NPT Coupling	3" NPT Coupling	2" NPT Coupling	3" NPT Coupling	3" NPT Coupling	4" NPT Coupling	2" NPT Coupling	3" NPT Coupling	4" NPT Coupling
	Suction Connection	1" NPT Coupling	2" NPT Coupling	3" NPT Coupling	4" NPT Coupling	2" NPT Coupling	3" NPT Coupling	2" NPT Coupling	3" NPT Coupling	3" NPT Coupling	4" NPT Coupling	2" NPT Coupling	3" NPT Coupling	4" NPT Coupling
<b>ENGINE</b>	Brand	Honda	Honda	Honda	Honda	Subaru	Subaru	Robin Hatz	Robin Hatz	Robin Hatz	Robin Hatz	Honda	Honda	Honda
	Model	GX-25	GX-120	GX-160	GX-240	EX16	EX17	N/A	N/A	N/A	N/A	GX-160	GX-240	GX-340
	Type	Air-Cooled, 4-Cycle Single Cylinder with Oil Sensor						Air-Cooled, 4-Cycle Single Cylinder				Air-Cooled, 4-Cycle Single Cylinder with Oil Sensor		
	Output (hp)	1.1	4.0	5.5	8.0	4.5	6.0	4.9	4.9	7.6	10.5	5.5	8.0	11.0
	RPM	2220	3600	3600	3600	4000	4000	3600	3600	3600	3600	3600	3600	3600
	Fuel	Unleaded Gasoline						Diesel				Unleaded Gasoline		
	Fuel Tank Capacity (USGallon)	0.15	0.66	0.95	1.59	0.95	0.95	0.78	0.78	1.3	1.3	0.95	1.6	1.7
	Continuous Run Time per Tank (hr.)	1.21	3.0	3.3	3.2	3.18	2.71	1.21	3.0	3.3	3.2	3.3	3.2	2.6
	Starting Method	Recoil Starter												
<b>DIMENSION</b>	Length (inches)	9	18 1/2	20 1/2	25	20 1/2	20 1/2	24 13/16	24 13/16	28 3/16	28 3/16	23 1/4	27 1/2	30 1/8
	Width (inches)	14	14 5/8	16 1/2	18	16 1/2	16 1/2	17 5/16	17 5/16	20 7/8	20 7/8	18 1/4	20 1/8	20 1/8
	Height (inches)	13	17 1/8	18 1/8	23 1/2	18 7/8	18 7/8	22 1/4	22 1/4	25 5/8	27 3/16	17 3/8	25 5/8	26
	Shipping Weight (lbs.)	12	55	64	109	60	64	95	97	172	203	82	136	160

# Engine Powered Pumps Specifications

EPT3-50RX - 100RX2 • THP-4070HA • TD5-200/300

EPT5-150HA/150YD • EPT4-150DPJD/DPQJD • EPT2-100DD/150DD • EPT3-150YD

	EPT3-50RX 2" Trash Pump	EPT3-80RX 3" Trash Pump	EPT3-100RX2 4" Trash Pump	THP-4070HA High Pressure Pump	TD5-200 2" Diaphragm Pump	TD5-300 3" Diaphragm Pump	EPT5-150HA 6" Gas Engine Trash Pump	EPT5-150YD 6" Diesel Engine Trash Pump	EPT4-150DPJD 6" Heavy Duty Trash Pump	EPT4-150DPQJD 6" Heavy Duty Trash Pump	EPT2-100DD 4" Heavy Duty Trash Pump	EPT2-150DD 6" Heavy Duty Trash Pump	EPT3-150YD 6" Trash Pump	
FLUID	Max. Capacity (GPM)	190	360	570	106	50	88	1000	1000	2400	2400	650	1450	940
	Max. Capacity (GPH)	11400	21600	34200	6360	3000	5280	60000	60000	144000	144000	39000	81000	56400
	Max. Head (ft.)	90	96	91	231	25	25	98	98	160	160	104	86	140
	Max. Solid Diameter (inches)	1	1 1/2	1 1/2	N/A	1 1/2	1 5/8	3		3		2	3	3
PUMP	Impeller Type	Semi-Open			Closed	Diaphragm		Semi-Open		Fully Enclosed		Semi-Open		
	Impeller (Diaphragm) Material	High Chrome Iron Casting			Aluminum	TPE		Stainless Steel		Cast Iron		Ductile Iron		
	Volute Casting Material	Cast Iron			N/A		Cast Iron							
	Wear Plate Material	Stainless Steel		Integral Part of Volute	N/A		Cast Iron			Rubber Lined Cast Iron		Ductile Iron		
	Pump Casing Material	Die Cast Aluminum			Sand Cast Aluminum		Aluminum		Cast Iron					
	Shaft Seal - Type / Material	Silicon Carbide Mechanical Seal				N/A		Silicon Carbide / Buna	Silicon Carbide / Buna	Tungsten Carbide / Silicon Carbide	Tungsten Carbide / Viton & 304 Stainless Steel		Carbon / Chrome Mechanical Seal	
	Seal Lubricant - Type	Water			N/A		Water	Water	Oil		Grease			
	Discharge Connection	2" NPT Coupling	3" NPT Coupling	4" NPT Coupling	1"x2, 1.5"x1 NPT Coupling	2" NPT Coupling	3" NPT Coupling	6" NPT Coupling	6" NPT Coupling	6" Ansi Flange		4" NPT Coupling	6" NPT Coupling	6" NPT Coupling
Suction Connection	2" NPT Coupling	3" NPT Coupling	4" NPT Coupling	1.5" NPT Coupling	2" NPT Coupling	3" NPT Coupling	6" NPT Coupling	6" NPT Coupling	6" Ansi Flange		4" NPT Coupling	6" NPT Coupling	6" NPT Coupling	
ENGINE	Brand	Subaru	Subaru	Subaru	Honda	Honda	Honda	Honda	Yanmar	John Deere	Deutz	Deutz	Yanmar	
	Model	EX17	EX27	EX35	GX-160	GX-120	GX-120	GX-670	3TNM72	4045TF290	D2011L102I	D2011L103I	3TNV88D	
	Type	Air-Cooled, 4-Cycle Single Cylinder with Oil Sensor						Air-cooled V-Twin with Oil Sensor	Liquid cooled, 4-cycle, 3 cylinder w/Tach, Hour meter / Oil Sensor	Liquid Cooled, 4-Cycle Four Cylinder with Temperature / Oil Sensor		Air/Oil Cooled, 4-cycle Two Cylinder w/Temperature/Oil Sensor	Air/Oil Cooled, 4-cycle Three Cylinder w/Temperature/Oil Sensor	Liquid cooled, 4 stroke, 3 cylinder
	Output (hp)	6.0	7.0	12.0	5.5	4.0		22.0	22.8	74		20	30	33
	RPM	4000		3600		3600		3600		2200		1800		2800
	Fuel	Unleaded Gasoline						Diesel						
	Fuel Tank Capacity (USGallon)	0.95		1.85	0.95	0.5		20	20	60	130	40	45	40
	Continuous Run Time per Tank (hr.)	3.28	2.71	2.8	3.3	2.0		12.0		24.0	30.0	38	29	11.5
	Starting Method	Recoil Starter						12V Electric start Battery not included			Electric, 12V			
DIMENSION	Length (inches)	23 1/4	27 1/2	30 1/8	21	39	42	99	99	136 1/2	161 1/2	106 1/8	112 3/4	108
	Width (inches)	18 1/4	20 1/8	20 1/8	16	26	30	48	48	67	76 1/8	65 1/2	65 1/2	60
	Height (inches)	17 3/8	25 5/8	26	18	23	22	60	60	67 7/8	79 13/16	70	70	69
	Shipping Weight (lbs.)	82	136	163	62	167	175	1125	1250	3360	4800	1960	2223	1750

# **TSURUMI PUMP** Portable Generators

**TSURUMI TPG3 / TPG Series Generators** are designed to withstand the severe conditions of construction jobsites or industrial applications, especially where extra durability and dependable, stable power are required. Ideal to supply the power to Tsurumi's single-phase submersible pumps and all your electrical power tools such as drills, saws, lighting and heaters.

## **TPG3 / TPG Series Generators Features** *powered by Honda*

- High Capacity Fuel Tank with Fuel Gauge for extended run time.
- Large, Silent Muffler with USDA qualified spark arrestor to greatly reduce noise.
- Optional Wheel Kits & Lifting Bail are available.  
(PGWK-200 for all TPG3 Series: Wheel Kit & Lifting Bail, PGWK-11K for TPG-11000HDXE: Wheel Kit only)

Powered by **Honda OHV engine** for efficient fuel and oil construction with oil alert system to shut off motor if oil fails below safe operating level.

Large Air Filter for **superior emission control**.

**Automatic Idle Control** reduces fuel consumption, noise, and engine wear.

Auto Idle Control Switch on Control Panel. (Not available on TPG3-3000HDX)

Rubber Vibration Pads isolate generator / engine set for **maximum protection and noise reduction**.

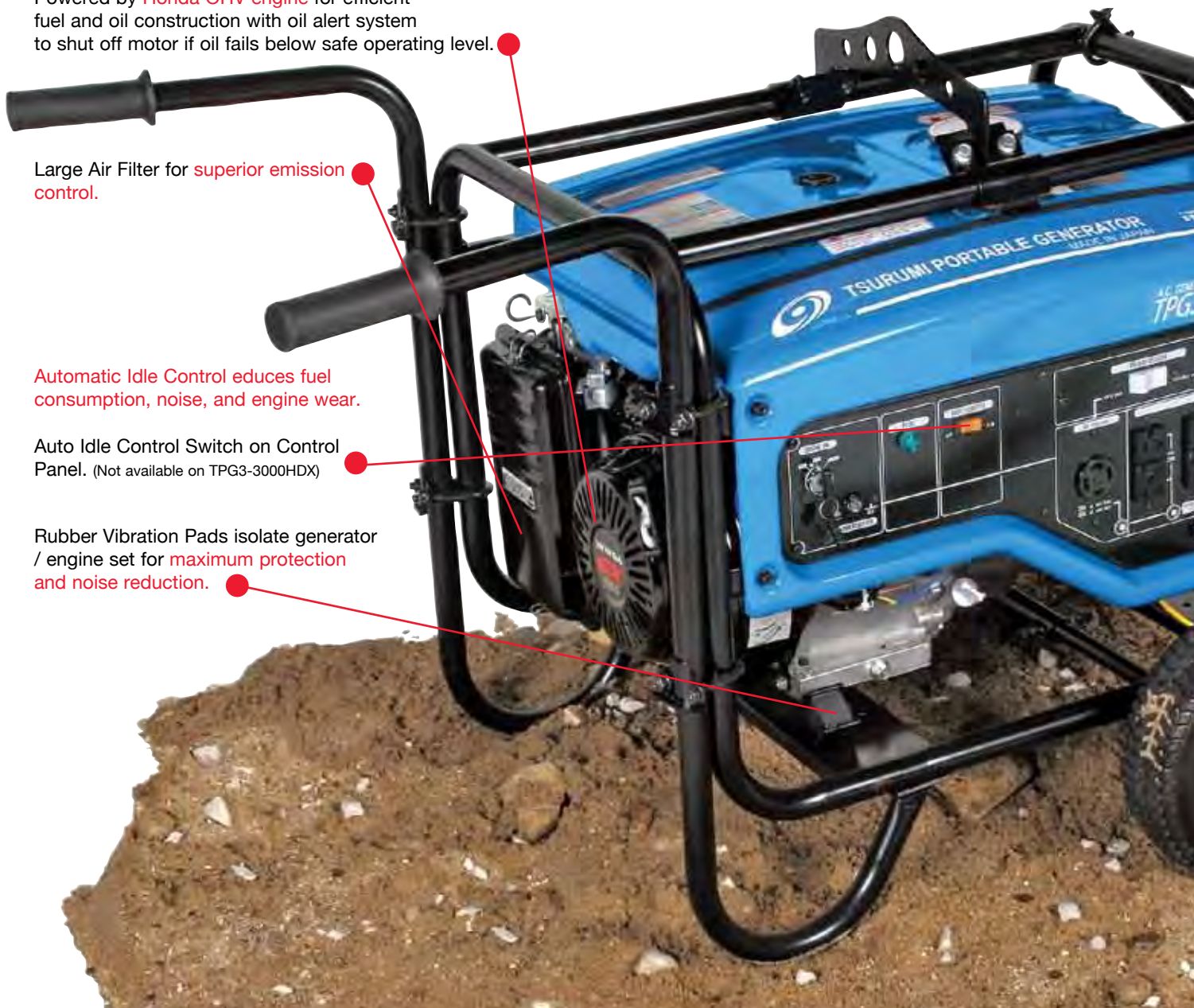

## TPG3 SERIES GENERATORS



	TPG3-3000HDX	TPG3-4500HDX	TPG3-6000HDX	TPG3-7000HDX TPG3-7000HDXE
Max. / Rated Output (watts)	2900 / 2400	4500 / 3600	6000 / 5000	7000 / 6000
Max. / Rated Current (120V / 240V)	24.2/20	37.5/30, 18.8/15	50/40, 25,20	58.3/50, 29.2/25
Voltage (V) (60Hz)	120	120/240	120/240	120/240
AC Outlet Replacement	1-NEMA 5-20R Duplex (20A, 12A, W/GFCI)	2-NEMA 5-20A Duplex (20A, 12A, W/GFCI) 1-NEMA L5-30R (30A, 120V, Twist Lock) 1-NEMA L14-20R (30A, 120/240V, Twist Lock)		2-NEMA 5-20A Duplex (20A, 12A, W/GFCI) 1-NEMA L5-30R (30A, 120V, Twist Lock) 1-NEMA L14-20R (30A, 120/240V, Twist Lock)
Engine Model	GX160	GX240	GX340	GX390
Maximum HP	5.5 (3600RPM)	8.0 (3600RPM)	11.0 (3600RPM)	13.0 (3600RPM)
Displacement	163 (10inch <sup>3</sup> )	242 (15inch <sup>3</sup> )	337 (21inch <sup>3</sup> )	389 (24inch <sup>3</sup> )
Fuel Tank Capacity (gallon)	6.6	6.6	6.6	6.6
Running Time (Rated load, 1/2 load)	11.9/16.6	11.4/16.4	8.5/12.2	7.9/11.8
Starting System	Recoil	Recoil	Recoil	Recoil (HDX), Electric (HDXE)
Noise Level (Rated Load)	64dB	68dB	72dB	78dB
Shipping Size (LxWxH) (inches)	23 5/8x16 1/2x19 3/4	27 3/16x21 1/4x20 1/4	27 3/16x21 1/4x20 1/4	27 3/16x21 1/4x20 1/4
Shipping Weight (lbs.)	102	157	176	185(HDX), 191 (HDXE)



## TPG-11000HDXE GENERATOR

	TPG-11000HDXE
Rated Output (1ph)	10.5 kVA
Max. Output (1ph)	11.5 kVA
Alternator	AVR
Frequency (Hz)	60
Phase	Single
Armature Connection	-
Power Factor	1.0
Receptacle (amperage rating and plug types)	2-NEMA 5-20R Duplex (20A, 120V, W/GFCI) 1-NEMA L5-30R (30A, 120V, Twist Lock) 1-NEMA L14-30R (30A, 120/240V Twist Lock) 1-NEMA L14-50R (50A, 120/240V Twist Lock)
Fuel Tank Capacity (gal.)	9.75
Engine	Honda GX630
Displacement of Engine	688 cc
HP @ rated speed	20.2HP
Emission	-
Noise Level (dB)	75 (reference data)
L x W x H (inch)	38.2 x 26.7 x 28.6
Weight (lbs.)	433

\*Specification subject to change \*Wheel Kit is optional

# TSURUMI PUMP Parts and Accessories



## Automatic Float Switch

TSURUMI's TS-series piggy-back float switches allow fast and easy installation of Tsurumi submersible pumps for automated operation. Simply tighten the float mounting strap to the discharge pipe, or other suitable support, and set the float tether length for the desired pumping range. (See chart below). Next, plug the pump into the float's piggy-back receptacle and plug into electrical outlet. All switches are UL Recognized and CSA Certified.

Tether Length	Pumping Range
3.5 inches	7 inches
6 inches	10 inches
10 inches	16 inches
14 inches	22 inches
18 inches	28 inches
22 inches	33 inches
24 inches	36 inches

Note: Due to cable weight, pumping range above horizontal is NOT equal to pumping range below horizontal. As tether length increases, so does the variance of the pumping range. Pumping ranges are based on testing in non-turbulent conditions. Actual conditions may vary. Use these values as a guide.



## Hoses and Suction Strainers

A range of hose and connectors are available. Both discharge (50ft) and suction hoses (20ft) available in 2", 3", and 4".

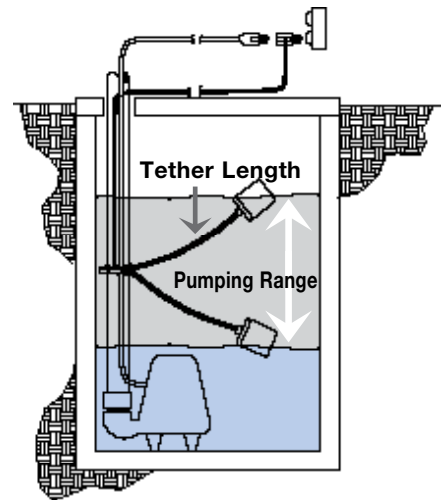

Automatic Float Switch

Pump Float Switches	Maximum Pump Running Current	Maximum Pump Starting Current	Required Nema Plug Configuration	For Pump Model	Cord Length (ft)
TS-301	13 amps / 120 VAC, 60Hz	85 amps / 120VAC, 60Hz	5-15P	HS2.4S (110V)	30
				LB-480 (110V)	30
TS-302	15 amps / 120 VAC, 60Hz	85 amps / 120VAC, 60Hz	5-15P	LB-800 (115V)	30
TS-303	15 amps / 250 VAC, 60Hz	85 amps / 250VAC, 60Hz	6-15P *	LB-800 (230V)	30
				NK2-15 (220V)	30
				NK2-22 (220V)	30



### Sand Kit Model: K15-SK

The Sand Kit can be added to the NK Series to suspend sand and prevent sand lock.



### Residue Kit Model: HS-RK

Available for the HS2.4S, the Residue Kit allows pumping of residual water down to 0.4 inches.

## Wheel Kit & Lifting Bail



Wheel Kit PGWK-200  
for TPG3 Series Generator &  
Gas Engine Pumps

Wheel Kit PGWK-11K  
for TPG-11000HDXE

Lifting Bail  
PGLB-1

### For All Generators, Gas Engine Pumps: Wheel Kit PGWK-200 / PGWK-11K and Lifting Bail PGLB-1

Heavy-duty and easy to install our wheel kits and lifting bails fit all of Tsurumi Generators.

## Control Panels



### For NK, KTZ, LH, and LHW Series MANUAL CONTROL PANEL INCLUDES:

- Manual Simplex Operation.
- Nema 4X, Lockable Fiberglass Enclosure.
- IEC Contactor.
- Hand/Off Selector Switch.
- UL Listed.
- Cable Grips In Control Panel.

### AUTOMATIC CONTROL PANEL INCLUDES:

- Automatic or Manual Simplex Operation.
- Nema 4X, Lockable Fiberglass Enclosure.
- IEC Rated Magnetic Contactor.
- Hand/Off Auto Selector Switch.
- UL Listed.
- Includes (2) 20 Ft. Mechanical Float Switches.
- Cable Grips In Control Panel.

Inverter Panels are available for LHW and KTZ series Single Phase operation.



# TSURUMI PUMP

## SUPERIOR DESIGN & TECHNOLOGY

**Anti-Wicking Cable Entrance:** Maximum protection against water incursion through the cable entry.

- Molded Cable Boot or Cable Protection Tube - extends cable bending radius, prevents abrading, and reduces fatigue.
- Cable Gland - provides 360 degree compression of cable boot, protection tube or cable bush for a water tight fit.
- Anti-Wicking Block - window cuts on conductor insulation expose strands to molded rubber or epoxy to prove water wicking through the strands and entering the motor providing protection even if the cable insulation is cut.

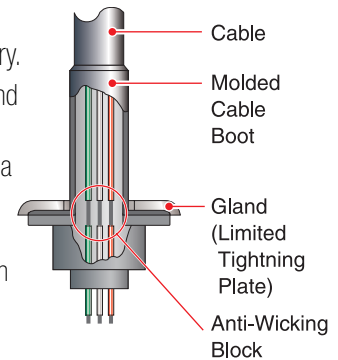

**Circle Thermal Protector (CTP) - for pumps with 1-10HP:** 3-Pole protector connects to each winding of the motor and reacts to excessive heat and amperage. Automatic reset at safe temperature to restart the motor. No motor protection circuit required in starter or control panel.

**V-Ring:** V-Ring is mounted at the top of the impeller and is brought in close contact to the bottom of the mechanical seal by the internal pressure of the pump casing. This V-Ring acts as a dust seal to prevent fine abrasive particles in the pumping fluid from reaching the mechanical seal.

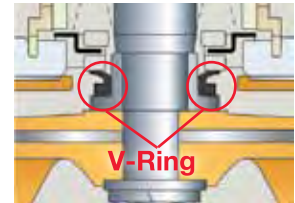

**High-Performance Motor:**

Dry type, squirrel-cage, induction motor, housed in a watertight casing, conforms to either insulation class B or E, or F. In both of these classes, all standard pumps can be used in ambient temperature up to 104°F (40°C).

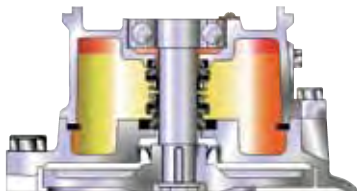

**Dual Inside, Silicon Carbide Mechanical Seals:**

Isolation of mechanical seals in an oil chamber provides a clean, non-corrosive and abrasion free lubricating environment to prevent spring failure due to corrosion or abrasion and bottom seal failure due to loss of cooling during dry-run conditions.

**Oil Lifter (Patented):** Tsurumi's exclusive Oil Lifter encloses the mechanical seal and uses the centrifugal force generated by the rotating shaft and seal to pump oil to the upper seal faces. Upper and lower seal faces are positively lubricated even when extremely low oil levels exist, as experienced after long periods of extended operation.

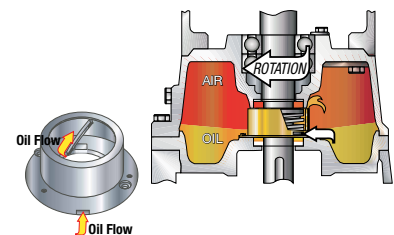

# TSURUMI PUMP

For Sales, Service, and Specifications, call:  
**1-888-TSURUMI (878-7864)**



**TSURUMI (AMERICA), INC.**  
1625 Fullerton Court  
Glendale Heights, IL 60139  
Tel: 1-888-878-7864 (Toll-Free)  
1-630-793-0127  
Fax: 1-630-793-0146



**TSURUMI (AMERICA), INC. WEST**  
6216 West 9790 South  
West Jordan, UT 84081  
Tel: 1-800-748-4458 (Toll-Free)  
1-801-563-5910  
Fax: 1-801-563-5911

Your Dealer

Visit our website: [www.tsurumipump.com](http://www.tsurumipump.com)